

**MULTIPURPOSE**  
**CHAIRS**

PRICELIST

**MANAGERIAL CHAIRS**  
**OPERATIVE CHAIRS**  
**CONFERENCE**  
**& VISITOR CHAIRS**  
**CAFE CHAIRS & OTHER**

## INDEX

@-sense	20	Goliat	126	Retro	86
Airgo	22	I-line	10	Rico Table	116
Alani	92	Irys	56	Rozana Table	115
Amigo	50	Iso	64	Rumba	56
Ammi	92	Jupiter	10	Samba	58
Arioso	50	Kaja Table	114	Saturn	18
Arizona hanger	125	Labo	126	Senior	128
Ascona	78	Lakka	104	Simple Table	120
Beta	52	Lantana	104	Sit.Net	28
Bingo	110	Lara Inox	114	Sit.On	28
Bistro Table	114	Lena Table	114	Smart	18
Cafe II	92	Linea	34	Smart RB	128
Cafe IV	92	Lynx	34	Sonata	46
Cafe VI	94	Madame	10	Squerto	104
Cafe VII	94	Malva	56	Step	72
Cafe IX	102	Manager	34	Styl	58
Cafe XII	102	Master	24	Sylwia S	60
Cafe LGW	82	Mirage	36	Table tops	122
Chester	34	Montana	12	Taktik	30
Chico	90	Nadir	36	Tiziano	78
Cinque	8	Nargo	126	Tiramisu Table	115
Club	54	Neron	78	Top hanger	125
Club SQ	54	Neo II	14	Tulipan	78
Columbia	54	Neo-Lux	42	Venus	80
Cortina	78	Next_U	44	Verbena	104
Cruzo	117	Nova	38	Vesta New	60
El Sol	78	Officer-Net	26	V-sit	62
Elva	54	Offix	16	Wait	70
Enjoy	8	Orion	38	Webst@r	18
Eryk Table	116	Orlando	40	Werek	128
Evora	86	Pegaz	16	Wing II	106
Fano	78	Polyfold	56	Worker	128
Flex	8	Prestige	16	Zafiro hocker	88
Fondo	84	Punkt	16	Zeppo	90
Gem	8	Quatro	16	Zeta	88

Valid from **April 2017**

© Copyright Nowy Styl Group

Nowy Styl Group reserves the rights to change the constructional features, upholsteries and prices of products.

## OPERATIVE CHAIRS 8-33

@-SENSE	20	JUPITER	10	OFFIX	16	SIT.NET	28
AIRGO	22	MADAME	10	PEGAZ	16	SMART	18
CINQUE	8	MASTER	24	PRESTIGE	16	TAKTIK	30
ENJOY	8	MONTANA	12	PUNKT	16	WEBST@R	18
FLEX	8	MONTANA PLUS	12	QUATRO	16		
GEM	8	NEO II	14	SATURN	18		
I-LINE	10	OFFICER-NET	26	SIT.ON	28		

## MANAGERIAL CHAIRS 34-49

CHESTER	34	MANAGER	34	NEO-LUX	42	ORION	38
LINEA	34	MIRAGE	36	NEXT_U	44	ORLANDO	40
LYNX	34	NADIR	36	NOVA	38	SONATA	46

## CONFERENCE & VISITOR CHAIRS 50-77

AMIGO	50	COLUMBIA	54	RUMBA	56	VESTA NEW	60
ARIOSO	50	ELVA	54	RUMBA S	56	V-SIT	62
BETA	52	ISO	64	SAMBA	58	WAIT	70
CINQUE 4L	54	IRYS	56	STEP	72		
CLUB	54	MALVA	56	STYL	58		
CLUB SQ	54	POLYFOLD	56	SYLWIA S	60		

## CAFE CHAIRS 78-105

ASCONA	78	FANO	78	LANTANA	104	TULIPAN	78
CORTINA	78	FONDO	84	NERON	78	VENUS	80
EL SOL	78	LAKKA	104	TIZIANO	78		

## CAFE LGW 82-83

ALANI LGW	82	CAFE IV LGW	82	CAFE IX LGW	83	LANTANA LGW	83
AMMI LGW	82	CAFE VI LGW	83	CAFE XII LGW	83	VERBENA LGW	83
CAFE II LGW	82	CAFE VII LGW	83	LAKKA LGW	83		

## CAFE BAR STOOLS 86-89

BINGO	110	FONDO	84	TULIPAN	86	ZETA	88
CAFE VII	96	RETRO	86	VENUS	88		
EVORA	86	RETRO TWIST	86	ZAFIRO	88		

## CAFE STOOLS 90-91

CHICO	90	ZEPPA	90				
-------	----	-------	----	--	--	--	--

## PLYWOOD CHAIRS 92-113

ALANI	92	CAFE IV	92	CAFE XII	102	VERBENA	104
AMMI	92	CAFE VI	94	LAKKA	104	WING II	106
BINGO	110	CAFE VII	94	LANTANA	104		
CAFE II	92	CAFE IX	102	SQUERTO	104		

## TABLES, TABLE BASES 114-124

BISTRO	114	KAJA	114	RICO	116	TIRAMISU	115
CRUZO	117	LARA INOX	114	ROZANA	115		
ERYK	116	LENA	114	SIMPLE	120		

## CHAIRS FOR SPECIAL PURPOSES 126-129

GOLIAT	126	NARGO	126	SMART RB	128	WORKER	128
LABO	126	SENIOR	128	WEREK	128		

## HANGERS 125

ARIZONA	125	TOP	125				
---------	-----	-----	-----	--	--	--	--

**0** PRICE GROUP: Basic fabric, Imitation Leather, Micro

<b>Basic fabric C</b>	Composition: Weight: Abrasion Resistance:	100% synthetic fibre 225 g/m <sup>2</sup> ≥35 000 Martindale cycles
<b>Imitation Leather V</b>	Composition: Weight: Abrasion Resistance: Flammability: Other:	100% PVC coated polyester 460 g/m <sup>2</sup> ≥30 000 Martindale cycles applies to colours marked as N: EN 1021-1, EN 1021-2, BS 5852-1 easy to keep clean
<b>Micro M</b>	Composition: Weight: Abrasion Resistance: Flammability: Other:	100% polyester 160 g/m <sup>2</sup> 50 000 Martindale cycles EN 1021-1, EN 1021-2 EN 71-1 safety of toys (mechanical and physical properties) EN 71-2 safety of toys (flammability) EN 71-3 safety of toys (migration of certain elements)

**1** PRICE GROUP: Bondai, Kaiman, Lucia, Oban, Sempre

<b>Bondai BN</b>	Composition: Weight: Abrasion Resistance: Flammability:	100% polyester 250 g/m <sup>2</sup> 150 000 Martindale cycles EN 1021-1, EN 1021-2, BS 7176 medium hazard, BS 5852 Crib 5
<b>Kaiman KN</b>	Composition: Weight: Abrasion Resistance: Flammability: Other:	upper layer: 100% polyurethane, bottom layer: 65% polyester, 35% cotton 435 g/m <sup>2</sup> 100 000 Martindale cycles BS 5885 source 0 Hydrolyse (DIN EN ISO 32100 (DIN 53351) / DIN 53359) - 15 000 cycles
<b>Lucia YB</b>	Composition: Weight: Abrasion Resistance: Flammability: Other:	100% recycled polyester. Non metallic dyestuffs 260 g/m <sup>2</sup> 50 000 Martindale cycles EN 1021-1, EN 1021-2, BS 7176 low hazard, BS 476 Class 1 Environmental: EU Ecolabel certified, recyclable
<b>Oban EF</b>	Composition: Weight: Abrasion Resistance: Flammability:	100% polypropylene 230 g/m <sup>2</sup> EN 14465 grade A EN 1021-1
<b>Sempre SM</b>	Composition: Weight: Abrasion Resistance: Flammability:	100% polyester 366 g/m <sup>2</sup> 160 000 Martindale cycles EN 1021-1, EN 1021-2

**2** PRICE GROUP: Contract, Era, Microfibr, Nexus, Valencia, Xtreme

<b>Contract YN</b>	Composition: Weight: Abrasion Resistance: Flammability: Other:	100% recycled polyester. Non metallic dyestuffs 320 g/m <sup>2</sup> 100 000 Martindale cycles EN 1021-1, EN 1021-2, BS 7176 low hazard, BS 7176 medium hazard, BS 5852 Crib 5, NF P 503 M1, DIN 4102 B1, UNI 9174 Classe 1 Environmental: EU Ecolabel certified, recyclable
<b>Era CSE</b>	Composition: Weight: Abrasion Resistance: Flammability:	100% polyester. Non metallic dyestuffs 320 g/m <sup>2</sup> ≥100 000 Martindale cycles EN 1021-1, EN 1021-2, BS 7176 low hazard
<b>Microfibr CM</b>	Composition: Weight: Abrasion Resistance: Flammability: Other:	83% polyester, 17% cotton 355 g/m <sup>2</sup> 100 000 Martindale cycles EN 1021-1, EN 1021-2 Zero Spot - protective layer against dirt, stains & water
<b>Nexus UNY</b>	Composition: Weight: Abrasion Resistance: Flammability:	100% polyester 300 g/m <sup>2</sup> 100 000 Martindale cycles EN 1021-1, EN 1021-2, BS 7176 low hazard
<b>Valencia VL</b>	Composition: Weight: Abrasion Resistance: Flammability: Other:	upper layer: 100% vinyl, bottom layer: 100% Hi-Loft polyester 650 g/m <sup>2</sup> 300 000 Martindale cycles EN 1021-1, EN 1021-2, DIN 4102 B2, NF P 92-503 M2, Önorm B 3825, Önorm A 3800-1 Q1 EN 71-3 Safety of toys (migration of certain elements) PERMABLOK3* - superior antibacterial, antistain and antifungal protection
<b>Xtreme XR</b>	Composition: Weight: Abrasion Resistance: Flammability: Other:	100% recycled polyester. Non metallic dyestuffs 310 g/m <sup>2</sup> 100 000 Martindale cycles EN 1021-1, EN 1021-2, BS 7176 low hazard, BS 7176 medium hazard, BS 5852 Crib 5, DIN 4102 B1, UNI 9174 Classe 1 Environmental: EU Ecolabel certified, recyclable

**3** PRICE GROUP: Flex, King L Elast, Oxygen, Runner, Silvertex, Split Leather Front SP front

<b>Flex XF</b>	Composition: Weight: Abrasion Resistance: Flammability:	100% polyester 450 g/m <sup>2</sup> 80 000 Martindale cycles EN 1021-1, EN 1021-2, Calif. Bull. 117E, Önorm B 3825, Önorm A 3800-1 Q1
<b>King L Elast K</b>	Composition: Weight: Abrasion Resistance: Flammability:	100% Trevira CS polyester 260 g/m <sup>2</sup> 70 000 Martindale cycles EN 1021-1, EN 1021-2, BS 7176 medium hazard, BS 5852 Crib 5, NF P 92-501-7 M1, DIN 4102 B1
<b>Oxygen OX</b>	Composition: Weight: Abrasion Resistance: Flammability:	90% wool, 10% polyamide 400 g/m <sup>2</sup> 100 000 Martindale cycles EN 1021-1, EN 1021-2, BS 7176 low hazard, UNI 9175 Classe 1.1M
<b>Runner RN</b>	Composition: Weight: Abrasion Resistance: Flammability:	100% polyester 318 g/m <sup>2</sup> 70 000 Martindale cycles EN 1021-1, EN 1021-2, Calif. Bull. 117E
<b>Silvertex SX</b>	Composition: Weight: Abrasion Resistance: Flammability: Other:	upper layer: 100% vinyl, bottom layer: 100% Hi-Loft polyester 685 g/m <sup>2</sup> 300 000 Martindale cycles EN 1021-1, EN 1021-2, DIN 4102 B1, NF P 92-503 M2, Önorm B 3825, Önorm A 3800-1 Q1 PERMABLOK3* - superior antibacterial, antistain and antifungal protection SILVERGUARD* - natural environmentally friendly bacteria fighting defense to inhibit odour and stain causing bacteria (silver ion technology)
<b>Split Leather SP front</b>	Composition:	split leather (1.1 - 1.3mm)

**4** PRICE GROUP: Blazer, Fame, LE Leather Front, SD Leather Front, Synergy

<b>Blazer CUZ</b>	Composition: Weight: Abrasion Resistance: Flammability: Other:	100% virgin wool. Non metallic dyestuffs 460 g/m <sup>2</sup> 50 000 Martindale cycles EN 1021-1, EN 1021-2, BS 7176 low hazard, UNI 9175 Classe 1.1M Environmental: EU Ecolabel certified. Renewable and Compostable
<b>Fame F</b>	Composition: Weight: Abrasion Resistance: Flammability: Other:	95% wool, 5% polyamide 435 g/m <sup>2</sup> 200 000 Martindale cycles EN 1021-1, EN 1021-2, BS 5852 source 0, BS 5852 source 1, BS 5852 Crib 5, Calif. Bull. 117E, UNI 9175 Classe 1.1M, NF D 60-013 AM 18, IMO A.652, IMO/MED Certificate Environmental: EU Ecolabel certified
<b>Fine Leather LE Front</b>	Composition:	soft grain leather (0.9-1.1mm), thoroughly dyed
<b>Fine Leather SD Front</b>	Composition:	soft grain leather (0.9-1.1mm), thoroughly dyed
<b>Synergy LDS</b>	Composition: Weight: Abrasion Resistance: Flammability:	95% wool, 5% polyamide 400 g/m <sup>2</sup> 100 000 Martindale cycles EN 1021-1, EN 1021-2, BS 7176 low hazard, UNI 9175 Classe 1.1M, NF D 60-013 AM18, Önorm B 3825, Önorm A 3800-1 Q1

**5** PRICE GROUP: Fine Leather LE, Fine Leather SD, Fine Leather Q

<b>Fine Leather LE</b>	Composition:	soft grain leather (0.9-1.1mm), thoroughly dyed
<b>Fine Leather SD</b>	Composition:	soft grain leather (0.9-1.1mm), thoroughly dyed
<b>Fine Leather Q</b>	Composition:	soft grain leather (1.2 - 1.4mm), thoroughly dyed

How to use the pricelist for operative chairs:

Choose <b>SELECTED PRODUCT</b>		Define <b>UPHOLSTERY GROUP</b>		
MODEL [mm]		Price Group		
		GROUP 0 (M, V, C)	GROUP 1 (BN, YB, EF, SM, KN)	GROUP 2 (CSE, YN, CM, UNY, VL, XR)
	<b>NEO II GTP9 ts06</b> with a Epron Synchron mechanism NEO TS06 GTP9 ES xx SH		253	277

The first (bold) name (eg. **Neo II GTP9 ts06 with an Epron Synchron mechanism**) is the trade name.  
The second name (Neo II TS06 GTP9 ES xx SH) is the invoice generated product code.

How to order:

A product code which reads **Neo II TS06 GTP9 ES SH** identifies the chair as:  
**Neo II** with an Epron Synchron mechanism (**ES**), fixed armrests made of aluminium with plastic pad (**GTP9**), plastic base (**TS06**) and 50mm castors for soft surfaces (**SH**).

To order please follow the table below:

Use a product code of selected chair	Change xx into fabric colour code	Change a castors code
Neo II TS06 GTP9 ES	xx	SH
<b>Neo II TS06 GTP9 ES</b>	<b>BN-4011</b>	<b>SHH</b>

How to use the pricelist for configurable chairs:

Choose <b>BASIC MODEL</b>		Add <b>OPTIONS</b> eg. armrests, castors/glides		Select <b>VERSION/BASE/FRAME</b> eg. chromium version		Define <b>UPHOLSTERY:</b> fabric type and colour code	
Model	Description	equipment/information	Symbol	Description	Versions	Contract   YN	
	ER 10 CPT Office swivel chair with a CP base (TS02). High upholstered armrests (RTS), 50mm castor	(black polypropylene)	<b>GTP8</b>	mechanism on a black upholstered backrest and an (RTS), 50mm castors for soft		BN3005 BN3005 BN3005	
		rests (up&down) with soft pads	<b>R9</b>		TS15 black polyamide pyramidal base		
		castors Ø50 for hard surfaces	<b>SHH</b>		ST12 POL chromium version		

How to order:

A product code which reads **MASTER 10 ACTIV1 R1F ST 01-CR SHH** identifies the chair as:  
**Master** with high backrest (**10**), ACTIV1 mechanism (**ACTIV1**), up&down armrests (**R1F**), steel, chromium plated base (**St 01-CR**) and 50mm castors for hard surfaces (**SHH**). If any option does not apply, do not leave empty space, continue adding other options

To order please follow the table below:

Chair line	Extras/Mechanism	Armrests	Base/Version	Fabric + fabric colour code	Castors/Glides
selected from MODEL/DESCRIPTION table	symbol selected from OPTIONS table	symbol selected from OPTIONS table	symbol selected from VERSIONS table	symbol selected from FABRIC SAMPLER	symbol selected from OPTIONS table
<b>MASTER 10</b>	<b>ACTIV1</b>	<b>R1F</b>	<b>ST 01-CR</b>	<b>YN-097</b>	<b>SHH</b>

How to use the pricelist for managerial chairs:

Choose <b>SELECTED PRODUCT</b>		Define <b>UPHOLSTERY GROUP</b>		
MODEL [mm]		Price Group		
		GROUP 0 (M, V, C)	GROUP 1 (BN, YB, EF, SM, KN)	GROUP 2 (YN, CM, UNY, VL, XR)
	<b>CHESTER HRU R23P2 steel 28 chrome</b> with an Epron Synchron mechanism CHESTER-HRU ST28-POL R23P2-CR-xx ES xx ESH	only in V 671	only in KN 693	only in CM, VL 733

How to order:

A product code which reads **CHESTER-HRU ST28-POL R23P2-CR ES ESH** identifies the chair as:  
Chester with an Epron Synchron mechanism, upholstered headrest (**HRU**), 2D adjustable armrests made of polished aluminium and plastic with upholstered pad (**R23P2-CR**), polished aluminium base (**ST28-POL**) and 65mm castors for soft surfaces (**ESH**).

To order please follow the table below:

Use a product code of selected chair	Change xx into finish colour code for arm pads	Change xx into fabric colour code for upholstery	Change a castors code
CHESTER-HRU ST28-POL R23P2-CR-xx ES xx ESH	R23P2-CR-xx	xx	ESH
<b>CHESTER-HRU ST28-POL</b>	<b>R23P2-CR-LE-01</b>	<b>LE-06</b>	<b>ESHH</b>

### How to use the pricelist for visitor chairs:

Choose <b>SELECTED PRODUCT</b>	Define <b>UPHOLSTERY GROUP</b>		
MODEL [mm]	Price Group		
	GROUP 0 (M, V, C)	GROUP 1 (BN, YB, EF, SM, KN)	GROUP 2 (CSE, YN, CM, UNY, VL, XR)
 <b>ISO alu &amp; bl</b> ISO 4L-zz xx GB	72	73	75

### How to order:

A product code which reads **ISO 4L-ARM-ALU GB** identifies the chair as:  
**ISO** with armrest (**ARM**) on a 4-leg frame in alu (RAL 9006) colour (**4L-ALU**) with plastic glides for soft floor (**GB**).

### To order please follow the table below:

Use a product code of selected chair	Change xx into fabric colour code
ISO 4L-ARM-ALU xx GB	xx
<b>ISO 4L-ARM-ALU xx GB</b>	<b>C-38</b>

### How to use the pricelist for cafe and plywood chairs:

Choose <b>SELECTED PRODUCT</b>	Define <b>UPHOLSTERY GROUP</b>		
MODEL [mm]	EXTRA CHARGE FOR UPHOLSTERED VERSIONS *		
	VERSIONS	GROUP 0 (M, V, C)	GROUP 1 (BN, YB, EF, SM, KN)
 <b>CAFE VII alu &amp; bl</b> CAFE-VII 4L-zz xx GB	SEAT PLUS	19	22
	PLUS	32	37
	B PLUS	46	51

### How to order:

A product code which reads **CAFE-VII 4L-ARM-CR NF GB** identifies the chair as:  
**CAFE-VI** with armrest (**ARM**) on a 4-leg chromium plated frame (**4L-CR**), with glides (**GB**).

Use a product code of selected chair	Add Options	Change zz into frame colour code	Change xx into finish colour code
CAFE-VII 4L-zz xx GB	ARM, CR	zz	xx
<b>CAFE-VII 4L-ARM-CR NF-xx xx GB</b>	<b>ARM-CR</b>	<b>ALU, BL, CR, RAL 7016, RAL 9003, RAL 4006, RAL 2003, RAL 3020, RAL 120 80 60</b>	<b>1.007</b>

## DICTIONARY

### Abbreviations used in technical descriptions:













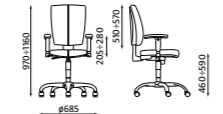

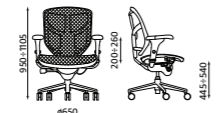





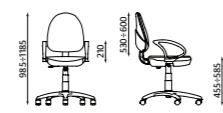

- A-PLUS** – fully upholstered seat and backrest
- B-PLUS** – front part of the chair fully upholstered
- BA** – backrest
- CTH** – coat hanger
- ESH** – castor Ø65 with selfbraking mechanism for soft surfaces
- ESHH** – castor Ø65 with selfbraking mechanism for hard surfaces
- ESH-W** – white castor Ø65 with selfbraking mechanism for soft surfaces
- ESHH-W** – white castor Ø65 with selfbraking mechanism for hard surfaces
- GB** – plastic glides for hard surfaces
- gtp** – fixed armrests
- gts** – chair without armrest
- HR** – plastic headrest
- HRU** – upholstered headrest
- HRUA** – upholstered & adjustable headrest
- HRM** – mesh headrest
- HRMA** – mesh & adjustable headrest
- NF** – arm pads
- LU** – lumbar support
- PC** – polycarbonate
- PF** – armchair armrest
- PLUS** – separately upholstered seat pad and backrest pads
- PP** – polypropylene
- R** – adjustable armrests
- rts** – chair without armrest with the possibility of fixing
- SE** – seat
- SEAT PLUS** – upholstered seat pad
- SH** – castor Ø50 with selfbraking mechanism for soft surfaces
- SHH** – castor Ø50 with selfbraking mechanism for hard surfaces
- SH-W** – white castor Ø50 with selfbraking mechanism for soft surfaces
- SHH-W** – white castor Ø50 with selfbraking mechanism for hard surfaces
- STW** – steel base with wooden overlay
- ST** – steel base
- TS** – plastic base
- TR** – plastic writing table for right-handed
- TR-xx** – wooden writing table for right-handed
- TL** – plastic writing table for left-handed
- TL-xx** – wooden writing table for left-handed



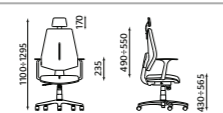

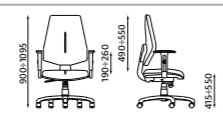

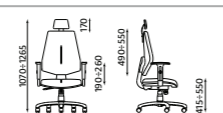









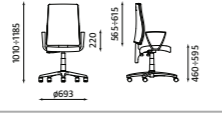



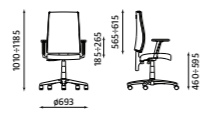

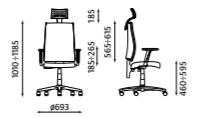





**NEO II GTP9 ts06**  
 with a Epron Synchron mechanism  
 NEO TS06 GTP9 ES xx SH

→ trade name



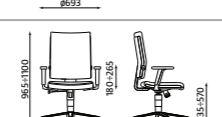

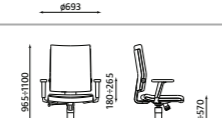

→ invoice generated product code

card box diameter [m <sup>2</sup> ]	no. of pcs per card box	no. of pcs per EURO pallet	no. of pcs per 1200 x 1000 mm pallet	net weight [kg]	seat of chair - width [mm]	seat of chair - depth [mm]	MODEL [mm]	3 YEARS WARRANTY YEARS 4
							@-SENSE	
							AIRGO	
							CINQUE 4L	
0.16	1			18.3	510	460	  CINQUE R2C ts02 with an ACTIV1 mechanism CINQUE TS02 R2C-CR ACTIV1 xx SH	
0.16	1			18	510	460	  CINQUE R2C steel02 chrome with an ACTIV1 mechanism CINQUE ST02-CR R2C-CR ACTIV1 xx SH	
0.23		6		25.8	520	425-480	  ENJOY R with a Synchron mechanism ENJOY-R KM11/BL ESH	
0.28		6		26.3	520	425-480	  ENJOY R HRMA with a Synchron mechanism ENJOY-R-HRMA KM11/BL ESH	
0.15	1	12		11.4	460	390	  FLEX 10 rts ts02 with an ACTIV1 mechanism FLEX-10 TS02 RTS ACTIV1 xx SH	
0.15	1	12		13.4	460	390	  FLEX 10 gtp17 ts02 with an ACTIV1 mechanism FLEX-10 TS02 GTP17 ACTIV1 xx SH	
0.15	1	12		11.4	460	390	  FLEX 10 RTS steel 01 chrome with an ACTIV1 mechanism FLEX-10 ST01 RTS ACTIV1 xx SH	
0.18	1	10		15.8	510	450	  GEM gtp46 ts06 with an ACTIV1 mechanism GEM TS06 GTP46 ACTIV1 xx SH	
0.18	1	10		16.1	510	450	  GEM HRU gtp46 ts06 with an ACTIV1 mechanism GEM-HRU TS06 GTP46 ACTIV1 xx SH	
0.18	1	10		15.8	510	450	  GEM R26S steel 04 chrome with an ACTIV1 mechanism GEM ST04-POL R26S ACTIV1 xx SH	
0.18	1	10		16.1	510	450	  GEM HRU R26S steel 04 chrome with an ACTIV1 mechanism GEM-HRU ST04-POL R26S ACTIV1 xx SH	

Price Group					
GROUP 0 (M, V, C)	GROUP 1 (BN, YB, EF, SM, KN)	GROUP 2 (YN, CM, UNY, VL, XR, CSE)	GROUP 3 (OX, SP FRONT, RN)	GROUP 4 (LE FRONT, SD FRONT, LDS)	GROUP 5 (LE, SD)
Prices on page 20					
Prices on page 22					
Prices on page 54					
	only in EF, YB, BN 322	only in XR, YN, CSE 334	only in OX 349		
	only in EF, YB, BN 351	only in XR, YN, CSE 362	only in OX 378		
seat and backrest in black mesh 975					
seat, backrest and headrest in black mesh 1028					
196	202	207			
223	229	234			
215	221	226			
only in M, C 287	only in BN, YB, EF, SM 296	only in YN, CM, UNY, XR, CSE 317	only in OX 333		
only in M, C 336	only in BN, YB, EF, SM 346	only in YN, CM, UNY, XR, CSE 366	only in OX 382		
only in M, C 349	only in BN, YB, EF, SM 360	only in YN, CM, UNY, XR, CSE 379	only in OX 395		
only in M, C 398	only in BN, YB, EF, SM 409	only in YN, CM, UNY, XR, CSE 428	only in OX 444		

card box diameter [m <sup>2</sup> ]	no. of pcs per card box	no. of pcs per EURO pallet	no. of pcs per 1200x1000 mm pallet	net weight [kg]	seat or chair - width [mm]	seat or chair - depth [mm]	MODEL [mm]		
									
0.185	1	10		11.8	480	410			<b>I-LINE rts ts16</b> with an Ergon 2L mechanism I-LINE TS16 RTS ERGON-2L xx SH
0.185	1	10		12.9	480	410			<b>I-LINE gtp45 ts16</b> with an Ergon 2L mechanism I-LINE TS16 GTP45 ERGON-2L xx SH
0.185	1	10		13.4	480	410			<b>I-LINE HR gtp45 ts16</b> with an Ergon 2L mechanism I-LINE-HR TS16 GTP45 ERGON-2L xx SH
0.185	1	10		12.9	480	410			<b>I-LINE R19T ts16</b> with an Ergon 2L mechanism I-LINE TS16 R19T ERGON-2L xx SH
0.185	1	10		13.4	480	410			<b>I-LINE HR R19T ts16</b> with an Ergon 2L mechanism I-LINE-HR TS16 R19T ERGON-2L xx SH
0.10	1	20		9.5	460	450			<b>JUPITER ergo rts ts12</b> with a CPT mechanism JUPITER-ERGO TS12 RTS PST01-CPT xx SH
0.10	1	20		12.4	460	450-480			<b>JUPITER ergo gtp6 ts12</b> with a CPT mechanism JUPITER-ERGO TS12 GTP6 PST01-CPT xx SH
0.185	1	10		17.3	498	425			<b>MADAME BLACK R19T ts16 ESH</b> with a Tilt mechanism MADAME-GC-BLACK TS16 R19T TILT/C xx ESH
0.185	1	10		17.3	498	425			<b>MADAME BLACK R19T steel 36 chrome ESH</b> with a Tilt mechanism MADAME-GC-BLACK ST36-POL/BI R19T TILT/C xx ESH
0.185	1	10		17.3	498	425			<b>MADAME WHITE R19T ts16 ESH</b> with a Tilt mechanism MADAME-GC-WHITE TS16 R19T TILT/C xx ESH
0.185	1	10		17.3	498	425			<b>MADAME WHITE R19T2 ts16 ESH</b> with a Tilt mechanism MADAME-GC-WHITE TS16 R19T2 TILT/C xx ESH
0.185	1	10		17.3	498	425			<b>MADAME WHITE R19T2 steel 36 chrome ESH-W</b> with a Tilt mechanism MADAME-GC-WHITE ST36-POL/BI R19T2 TILT/C xx ESH-W

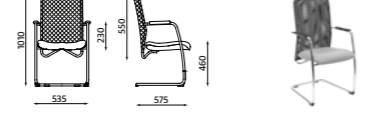
GROUP 0 (M, V, C)	Price Group				
	GROUP 1 (BN, YB, EF, SM, KN)	GROUP 2 (YN, CM, UNY, VL, XR, CSE)	GROUP 3 (OX, SP FRONT, RN)	GROUP 4 (LE FRONT, SD FRONT, LDS)	GROUP 5 (LE, SD)
226	231	245	only in OX 260		
245	250	264	only in OX 279		
261	266	280	only in OX 295		
283	288	303	only in OX 317		
283	288	303	only in OX 317		
122	129	134			
132	137	143			
	414	430	only in OX 441		
	477	493	only in OX 504		
	420	436	only in OX 447		
	427	442	only in OX 454		
	487	503	only in OX 514		

card box diameter [m <sup>2</sup> ]	no. of pcs per card box	no. of pcs per EURO pallet	no. of pcs per 1200x1000 mm pallet	net weight [kg]	seat of chair - width [mm]	seat of chair - depth [mm]	MODEL [mm]	3 YEARS WARRANTY YEARS 4
								<b>MASTER</b>
0.15	1	10		15.3	485	420	 <p><b>MONTANA R15G steel 11 chrome with an Epron Synchron mechanism</b> MONTANA ST11-POL R15G-CR ES BA-xx SE-xx SH</p>	
0.15	1	10		16.5	485	420-480	 <p><b>MONTANA R15G steel 11 chrome with an Epron Synchron mechanism and seat sliding system</b> MONTANA ST11-POL R15G-CR EST BA-xx SE-xx SH</p>	
0.21	1	9		16.5	485	420	 <p><b>MONTANA HB LU R15G steel 11 chrome with an Epron Synchron Plus mechanism</b> MONTANA-HB-LU ST11-POL R15G-CR ESP BA-xx SE-xx SH</p>	
						420-480	 <p><b>MONTANA HB LU R15G steel 11 chrome with an Epron Synchron Plus mechanism and seat sliding system</b> MONTANA-HB-LU ST11-POL R15G-CR ESPT BA-xx SE-xx SH</p>	
0.4	1	4		10	485	440	 <p><b>MONTANA LUX cfp chrome</b> MONTANA-LUX CFP-CR NF9-xx BA-xx SE-xx GBF</p>	
0.15	1	10		16.5	485	420-480	 <p><b>MONTANA PLUS TS25 RTS* with an Epron Synchron mechanism</b> MONTANA-PLUS TS25 RTS ES CR BA-RNxx SE-RN60999/RNxx</p>	











\* The front of the seat upholstered in black 3D mesh (Runner RN); seat sides and backrest upholstered in the same 3D mesh available in various colours from the standard Nowy Styl Group palette.

OPTIONS FOR MONTANA-PLUS

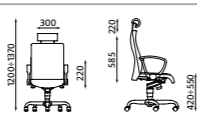
Additional equipment/information	Symbol	Extra charge
Fixed armrests	<b>GTP42</b>	24
Fixed armrests	<b>GTP46</b>	24
Height adjustable armrests	<b>R19T</b>	49
Folding height adjustable armrests	<b>R28S</b>	54
3D adjustable armrests	<b>R32R</b>	91
Ø 50 mm castor for hard surfaces	<b>SHH</b>	without extra charge

Price Group					
GROUP 0 (M, V, C)	GROUP 1 (BN, YB, EF, SM, KN)	GROUP 2 (YN, CM, UNY, VL, XR, CSE)	GROUP 3 (OX, SP FRONT, RN)	GROUP 4 (LE FRONT, SD FRONT, LDS)	GROUP 5 (LE, SD)
Prices on page 24					
361	367	378	388		
385	391	402	412		
435	442	453	462		
459	465	477	486		
377	383	394	404		
			only in RN 345		



card box diameter [m <sup>2</sup> ]	no. of pcs per card box	no. of pcs per EURO pallet	no. of pcs per 1200x1000 mm pallet	net weight [kg]	seat of chair - width [mm]	seat of chair - depth [mm]	MODEL [mm]		
									
0.18	1	10		15.5	485	445			<b>NEO II rts ts06 with a Tilt mechanism</b> NEO TS06 RTS TILT/C XX SH
0.18	1	10		16.5	485	445			<b>NEO II GTP9 ts06 with a Tilt mechanism</b> NEO TS06 GTP9 TILT xx SH
0.18	1	9		15.5	485	445			<b>NEO II rts ts06 with a Epron Synchron mechanism</b> NEO TS06 RTS ES xx SH
0.18	1	9		16.5	485	445			<b>NEO II GTP9 ts06 with a Epron Synchron mechanism</b> NEO TS06 GTP9 ES xx SH
0.18	1	9		15.5	485	445			<b>NEO II rts ts06 with a Duetto Synchron/MPD-165/mechanism</b> NEO TS06 RTS MPD165 xx SH
0.18	1	9		16.5	485	445			<b>NEO II gtp9 ts06 with a Duetto Synchron/MPD-165/mechanism</b> NEO TS06 GTP9-BL MPD165 xx SH
0.20	1	9		18.7	490	470			<b>NEO II HRUA gtp9 ts06 with a Duetto Synchron/MPD-165/mechanism</b> NEO-II-HRUA TS06 GTP9-CR MPD165 xx SH
								<b>BASE STEEL 02 alu for NEO II office chairs</b> ST02-ALU (instead of TS06)	
								<b>BASE STEEL 02 chrome for NEO II office chairs</b> ST02-CR (instead of TS06)	
								<b>LUMBAR SUPPORT for NEO II office chairs</b> LU	
0.185	1	9		14.1	490	460			<b>OFFIX rts ts16 with an Ibra mechanism</b> OFFIX TS16 RTS SYNCROIBRA xx SH

Price Group					
GROUP 0 (M, V, C)	GROUP 1 (BN, YB, EF, SM, KN)	GROUP 2 (YN, CM, UNY, VL, XR, CSE)	GROUP 3 (OX, SP FRONT, RN)	GROUP 4 (LE FRONT, SD FRONT, LDS)	GROUP 5 (LE, SD)
	228	252	274		
	253	277	303		
	303	327	349		
	327	350	373		
	357	381	403		
	381	404	411		
	479	519	540		
			19		
			29		
			24		
only in M, C 261	only in BN, YB, EF, SM 269	only in YN, UNY, XR, CSE 282	only in OX 291		

card box diameter [m]	no. of pcs per card box	no. of pcs per EURO pallet	no. of pcs per 1200x1000 mm pallet	net weight [kg]	seat of chair - width [mm]	seat of chair - depth [mm]	MODEL [mm]		
							  		
0.185	1	9		15.9	490	460			<b>OFFIX GTP41 ts16 with an Ibra mechanism</b> OFFIX TS16 GTP41 SYNCROIBRA xx SH
0.185	1	9		15.9	490	460			<b>OFFIX R15G-3 ts16 with an Ibra mechanism</b> OFFIX TS16 R15G-3-CR SYNCROIBRA xx SH
0.12	1		20	10.5	460	435-450			<b>PEGAZ ergo rts ts02 with a CPT mechanism</b> PEGAZ-ERGO TS02 RTS PST01-CPW xx SH
0.12	1		20	11.2	460	435-450			<b>PEGAZ ergo gtp2 ts02 with a CPT mechanism</b> PEGAZ-ERGO TS02 GTP2 PST01-CPW xx SH
0.12	1		20	12.7	465	365-80			<b>PEGAZ ergo gtp2 steel 02 chrome with a CPT mechanism</b> PEGAZ-ERGO ST02-CR GTP2 PST01-CPW xx SH
0.10	1	20		11.9	460	445-470			<b>PRESTIGE profil rts ts12 with a CPT mechanism</b> PRESTIGE-PROFIL TS12 RTS PST01-CPW xx SH
0.10	1	20		12.3	460	445-470			<b>PRESTIGE profil gtp4 ts12 with a CPT mechanism</b> PRESTIGE-PROFIL TS12 GTP4 PST01-CPW xx SH
0.148	1	12		11.5	460	350			<b>PUNKT ergo RTS ts02 with an Ergon 2L mechanism</b> PUNKT-ERGO TS02 RTS ERGON-2L xx SH
0.148	1	12		11.5	460	350			<b>PUNKT ergo gtp47 ts02 with an Ergon 2L mechanism</b> PUNKT-ERGO TS02 GTP47 ERGON-2L EF031 SH
0.18	1	9		15.3	510	460			<b>QUATRO R2C steel 04 chrome with an ACTIV1 mechanism</b> QUATRO ST04-POL R2C-CR ACTIV1 xx ESH
0.21	1	9		16	510	460			<b>QUATRO HRU R2C steel 04 chrome with an ACTIV1 mechanism</b> QUATRO-HRU ST04-POL R2C-CR ACTIV1 xx ESH
0.10	1	20		9.5	460	405-440			<b>SATURN ergo rts ts02 with a CPT mechanism</b> SATURN-ERGO TS02 RTS PST01-CPT xx SH

Price Group					
GROUP 0 (M, V, C)	GROUP 1 (BN, YB, EF, SM, KN)	GROUP 2 (YN, CM, UNY, VL, XR, CSE)	GROUP 3 (OX, SP FRONT, RN)	GROUP 4 (LE FRONT, SD FRONT, LDS)	GROUP 5 (LE, SD)
only in M, C 303	only in BN, YB, EF, SM 310	only in YN, UNY, XR, CSE 323	only in OX 333		
only in M, C 339	only in BN, YB, EF, SM 347	only in YN, UNY, XR, CSE 360	only in OX 369		
130	136	142			
150	157	163			
179	185	192			
114	121	127			
143	149	156			
only in M, C 185	only in BN, YB, EF, SM 195	only in YN, CM, UNY, XR, CSE 206	only in OX 216		
only in M, C 185	only in BN, YB, EF, SM 195	only in YN, CM, UNY, XR, CSE 206	only in OX 216		
only in M, C 376	only in BN, YB, EF, SM 385	only in YN, CM, UNY, XR, CSE 400	only in OX 412		
only in M, C 427	only in BN, YB, EF, SM 437	only in YN, CM, UNY, XR, CSE 451	only in OX 464		
114	119	124			

card box diameter [m <sup>2</sup> ]	no. of pcs per card box	no. of pcs per EURO pallet	no. of pcs per 1200x1000 mm pallet	net weight [kg]	seat of chair - width [mm]	seat of chair - depth [mm]	MODEL [mm]	
0.1	1	20		10.7	460	415-460	<b>SATURN ergo gtp6 ts02 with a CPT mechanism</b> SATURN-ERGO TS02 GTP6 PST01-CPT XX SH	
<b>SIT.ON/SIT.NET</b>								
0.10	1	20		10.5	460	425-465	<b>SMART rts ts02 with a CPT mechanism</b> SMART TS02 RTS PST01-CPW xx SH	
0.10	1	20		11.5	460	425-465	<b>SMART gtp27 ts02 with a CPT mechanism</b> SMART TS02 GTP27 PST01-CPW xx SH	
0.10	1	20		10.5	460	425-465	<b>SMART white rts ts02 with a CPT mechanism</b> SMART-WHITE TS02-K32 RTS PST01-W-CPW xx SH-W	
0.10	1	20		11.5	460	425-465	<b>SMART white gtp27 ts02 with a CPT mechanism</b> SMART-WHITE TS02-K32 GTP27 PST01-BI-CPW xx SH-W	
0.12	1	14	20	10.5	460	425-465	<b>SMART rts steel 01 chrome with a CPT mechanism</b> SMART ST01-CR RTS PST01-CPW XX SH	
<b>TAKTIK</b>								
0.10	1	20		10.8	470	425-465	<b>WEBST@R rts profil ts02 with a CPT mechanism</b> WEBST@R-PROFIL TS02 RTS PST01-CPA xx SH	
0.10	1	20		11.5	470	425-465	<b>WEBST@R gtp2 profil ts02 with a CPT mechanism</b> WEBST@R-PROFIL TS02 GTP2 PST01-CPA xx SH	
0.10	1	20		12	470	425-465	<b>WEBST@R R1E profil ts02 with a CPT mechanism</b> WEBST@R-PROFIL TS02 R1E PST01-CPA xx SH	

Price Group					
GROUP 0 (M, V, C)	GROUP 1 (BN, YB, EF, SM, KN)	GROUP 2 (YN, CM, UNY, VL, XR, CSE)	GROUP 3 (OX, SP FRONT, RN)	GROUP 4 (LE FRONT, SD FRONT, LDS)	GROUP 5 (LE, SD)
124	129	134			

Prices on page 28

119	122	only in YN, UNY, XR, CSE 127			
135	138	only in YN, UNY, XR, CSE 143			
127	130	only in YN, UNY, XR, CSE 135			
143	146	only in YN, UNY, XR, CSE 151			
152	155	only in YN, UNY, XR, CSE 160			

Prices on page 30

only in M, C 138	only in BN, YB, EF, SM 141	only in YN, UNY, XR, CSE 146			
only in M, C 153	only in BN, YB, EF, SM 156	only in YN, UNY, XR, CSE 161			
only in M, C 186	only in BN, YB, EF, SM 189	only in YN, UNY, XR, CSE 194			



Additional equipment/information	Symbol	Extra charge
Black fixed armrests with pads made of polyurethane	<b>GTP57K2</b>	40
Height adjustable armrests made of black plastic	<b>R35K2</b>	48
2-D armrests made of black plastic	<b>R35K2-SB2</b>	73
3-D armrests made of black plastic	<b>R35K3</b>	83
4-D armrests made of black plastic	<b>R35K3-SB2</b>	99
White backrest frame, white connector, white base TS25W	<b>W1</b>	16
White backrest frame, white connector	<b>W2</b>	16
White backrest frame	<b>W3</b>	16
White fixed armrests with pads made of polyurethane	<b>GTP57K2-W</b>	48
Height adjustable armrests made of black and white plastic	<b>R35K2-W/B</b>	56
2-D armrests made of black and white plastic	<b>R35K2-W/B-SB2</b>	83
3-D armrests made of black and white plastic	<b>R35K3-W/B</b>	91
4-D armrests made of black and white plastic	<b>R35K3-W/B-SB2</b>	107
Seat depth adjustment (FS mechanism)	<b>FST</b>	24
Seat depth adjustment (LP11 mechanism)	<b>LP11T</b>	25
Seat depth and negative seat inclination adjustment (LP11 mechanism)	<b>LP11TN</b>	33
Ø 50 mm self-braking castors for hard surfaces	<b>SHH</b>	without extra charge
Ø 60 mm self-braking castors for soft surfaces	<b>ESH</b>	29
Ø 60 mm self-braking castors for hard surfaces	<b>ESHH</b>	without extra charge
Injected foam on seat	<b>PW</b>	8

Apart from the product number/code, please specify option symbol, fabric and finish codes to complete an order.

ARMREST DIMENSION FOR @-SENSE CHAIRS

ARMREST TYPE	DIMENSION [mm]				WEIGHT [kg]
	A*	B	C	D	
<b>GTP57K2</b>	225	225	460	620	1.25
<b>R35K2</b>	200-280	225	490	650	1.60
<b>R35K3</b>	220-300	230	480	660	1.80
<b>R35K2 SB2</b>	190-270	225	460-510	620-670	2.45
<b>R35K3 SB2</b>	210-290	230	450-500	630-680	2.65

\* Dimensions measured under load in accordance with the EN standard.

@-SENSE SWIVEL CHAIRS

Model	Description	Price group				
		1	2	3	4	5
<p><b>@-SENSE-BL FS</b></p>	Swivel chair with synchronous mechanism (FS). Mesh backrest, mesh in black. Upholstered seat, seat sides in selected upholstery, black. Chair without armrests (RTS). Polyamide base (TS25-BL). Ø 50 mm self-braking castors for soft surfaces (SH). Black version - elements in black: backrest frame, connector, base, gaslift.	375	387	399	407	441
<p><b>@-SENSE-PLUS-BL FS</b></p>	Swivel chair with synchronous mechanism (FS). Upholstered backrest with decorative element welded ultrasonically. Upholstered seat, seat sides in selected upholstery, black. Chair without armrests (RTS). Polyamide base (TS25-BL). Ø 50 mm self-braking castors for soft surfaces (SH). Black version - elements in black: backrest frame, connector, base, gaslift.	Available only in Bondai: BN1005, BN4011, BN6016, BN8033, BN8010 433				
<p><b>@-SENSE-BL LP11</b></p>	Swivel chair with synchronous mechanism (LP11). Mesh backrest, mesh in black. Upholstered seat, seat sides in selected upholstery, black. Chair without armrests (RTS). Polyamide base (TS25-BL). Ø 50 mm self-braking castors for soft surfaces (SH). Black version - elements in black: backrest frame, connector, base, gaslift.	458	469	482	490	523
<p><b>@-SENSE-PLUS-BL LP11</b></p>	Swivel chair with synchronous mechanism (LP11). Upholstered backrest with decorative element welded ultrasonically. Upholstered seat, seat sides in selected upholstery, black. Chair without armrests (RTS). Polyamide base (TS25-BL). Ø 50 mm self-braking castors for soft surfaces (SH). Black version - elements in black: backrest frame, connector, base, gaslift.	Available only in Bondai: BN1005, BN4011, BN6016, BN8033, BN8010 514				

PRICE GROUP 1: Bondai, Lucia, Sempre, Kaiman  
PRICE GROUP 2: Era, Microfibr, Contract, Nexus, Valencia, Xtreme

PRICE GROUP 3: Oxygen  
PRICE GROUP 4: Synergy

PRICE GROUP 5: Leather LE, Leather SD



OPTIONS FOR AIRGO CHAIRS

Additional equipment/information	Symbol	Extra charge
Fixed armrests (black polypropylene)	<b>GTP8</b>	24
Adjustable armrests (up&down) with soft pads	<b>R9</b>	57
Selfbraking castors Ø50 for hard surfaces	<b>SHH</b>	without extra charge

Apart from the product number/code, please specify option symbol, fabric and finish codes to complete an order.

AIRGO SWIVEL CHAIRS

Model	Description	Versions	Price group			
			0	1	2	3
<b>AIRGO 10 CPT</b> 	Office swivel chair with a CPT mechanism on a black polyamide base (TS06). High upholstered backrest and an upholstered seat. No armrests (RTS), 50mm castors for soft surfaces (SH).		207	215	223	234
		ST12-POL chromium version	83			
<b>AIRGO 10 ACTIV1</b> 	Office swivel chair with an ACTIV1 mechanism on a black polyamide base (TS06). High upholstered backrest and an upholstered seat. No armrests (RTS), 50mm castors for soft surfaces (SH).		241	249	257	268
		ST12-POL chromium version	83			

PRICE GROUP 0: Micro, Imitation Leather, Basic fabric  
 PRICE GROUP 1: Oban, Bondai, Lucia, Sempre, Kaiman

PRICE GROUP 2: Microfibr, Contract, Nexus, Valencia, Xtreme, Era

PRICE GROUP 3: Oxygen



OPTIONS FOR MASTER CHAIRS

Additional equipment/information	Symbol	Extra charge
Window (for MASTER 10)	<b>W</b>	10
Injected Foam	<b>PW</b>	29
Fixed armrests	<b>GTP20</b>	56
Height adjustable armrest	<b>R1F</b>	59
Selfbraking castors Ø 50 for hard surfaces	<b>SHH</b>	without extra charge

Apart from the product number/code, please specify option symbol, fabric and finish codes to complete an order.

MASTER SWIVEL CHAIRS

Model	Description	Versions	Price group			
			0	1	2	3
<b>MASTER 10 CPT</b> 	Office swivel chair with a CPT mechanism on a black polyamide base (TS02). High upholstered backrest and an upholstered seat. No armrests (RTS), 50 mm castors for soft surfaces (SH).	ST01-ALU powder coated RAL 9006	185	195	209	222
		ST01-CR chromium version	29			
<b>MASTER 10 ACTIV1</b> 	Office swivel chair with an ACTIV1 mechanism on a black polyamide base (TS02). High upholstered backrest and an upholstered seat. No armrests (RTS), 50 mm castors for soft surfaces (SH).	ST01-ALU powder coated RAL 9006	212	222	236	249
		ST01-CR chromium version	29			
<b>MASTER 10 IM670</b> 	Office swivel chair with an Imarc-670 mechanism on a black polyamide base (TS06). High upholstered backrest and an upholstered seat. No armrests (RTS), 50 mm castors for soft surfaces (SH).	ST02-ALU powder coated RAL 9006	295	304	319	333
		ST02-CR chromium version	29			

PRICE GROUP 0: Micro, Basic fabric  
PRICE GROUP 1: Oban, Lucia, Sempre

PRICE GROUP 2: Contract, Xtreme, Era  
PRICE GROUP 3: Oxygen

# Officer-Net



## OFFICER-NET SWIVEL CHAIR

Additional equipment/information	Symbol	Extra charge
Height adjustable armrests with PU pads	<b>R19I</b>	49
Seat depth adjustment mechanism	<b>EST</b>	24
65 mm castors for hard surfaces	<b>ESHH</b>	without extra charge

Apart from the product number/code, please specify option symbol, fabric and finish codes to complete an order.

# Officer-Net

## OFFICER-NET SWIVEL CHAIR

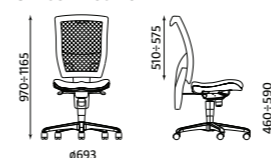
Model	Description	Versions	Price group				
			1	2	3	4	5
<b>Officer-Net ES</b> 	Swivel chair with a synchro mechanism (ES) on a black polyamide base (TS16). Mesh backrest and an upholstered seat. No armrests, 65 mm castors for soft surfaces.	TS16 black polyamide	364	372	380	388	414
		TS25 black polyamide base	32				

PRICE GROUP 1: Bondai, Lucia, Sempre, Kaiman, Oban  
 PRICE GROUP 2: Contract, Microfibra, Nexus, Valencia, Xtreme

PRICE GROUP 3: King L Elast, Oxygen, Silvertex, Flex  
 PRICE GROUP 4: Blazer, Fame

PRICE GROUP 5: Fine Leather LE, Fine Leather SD, Fine Leather Q

# Sit.On/Sit.Net



## OPTIONS FOR SIT.ON/SIT.NET CHAIRS

Additional equipment/information	Symbol	Extra charge
Height adjustable armrests with PU pads	<b>R19I</b>	49
Combination of polished and painted in white aluminium	<b>ST36 CR</b>	48
Height adjustable armrest 3D adjustable armrest	<b>R15K</b>	84
Seat depth adjustment	<b>EST</b>	24
Adjustable in height and angle upholstered headrest	<b>HRUA</b>	49
Adjustable lumbar support for Sit.Net	<b>LU</b>	29
Selfbraking castors Ø65 for hard surfaces	<b>ESHH</b>	without extra charge

Apart from the product number/code, please specify option symbol, fabric and finish codes to complete an order.

# Sit.On/Sit.Net

## SIT.ON/SIT.NET SWIVEL CHAIRS

Model	Description	Versions	Price group		
			1	2	3
<b>SIT.NET ES</b> 	Office swivel chair with an Epron Synchron (ES) mechanism on a black polyamide base (TS16). High mesh backrest and an upholstered seat. No armrests (RTS), 65 mm castors for soft surfaces (ESH).		414	504	514
<b>SIT.ON ES</b> 	Office swivel chair with an Epron Synchron (ES) mechanism on a black polyamide base (TS16). High upholstered backrest and an upholstered seat. No armrests (RTS), 65 mm castors for soft surfaces (ESH).		496	522	538

## SIT.ON/SIT.NET SIDE CHAIRS

Model	Description	Price group		
		1	2	3
<b>SIT.NET CFP</b> 	Visitor sledge chair on a chrome frame. Upholstered seat and mesh backrest.	583	598	614
<b>SIT.ON CFP</b> 	Visitor sledge chair on a chrome frame. Upholstered seat and backrest.	598	622	637

PRICE GROUP 1: Oban, Lucia, Sempre, Bondai  
PRICE GROUP 2: Contract, Nexus, Xtreme

PRICE GROUP 3: Oxygen





OPTIONS FOR TAKTIK

Additional equipment/information	Symbol	Extra charge
Fixed armrests	<b>GTP42</b>	24
Fixed armrests	<b>GTP46</b>	24
Folding height adjustable armrests	<b>R28S</b>	54
Height adjustable armrests	<b>R19T</b>	49
3D adjustable armrests	<b>R32R</b>	91
Seat depth adjustment for synchronous mechanism (ACTIV1)	<b>ACTIV-TR</b>	16
Seat depth adjustment for self-tension mechanism (SFB1)	<b>SFT1</b>	40
Lumbar support (applicable to Taktik Mesh, Taktik Mesh U, Taktik Mesh Ergo U)	<b>LU</b>	16
5-star plastic base	<b>TS06</b>	without extra charge
Ø 50 mm castor for hard surfaces	<b>SHH</b>	without extra charge

Apart from the product number/code, please specify option symbol, fabric and finish codes to complete an order.

TAKTIK SWIVEL CHAIRS

Model	Description	Price group			
		0	1	2	3
<b>TAKTIK TS16 RTS ACTIV1</b> 	Office swivel chair with an ACTIV1 mechanism on a black polyamide base (TS16). Upholstered backrest and seat. No armrests (RTS), 50 mm castors for soft surfaces (SH).	252	257	272	285
<b>TAKTIK TS16 RTS ERGON-UP</b> 	Office swivel chair with ERGON UP mechanism on a black polyamide base (TS16). Upholstered backrest and seat. No armrests (RTS), 50 mm castors for soft surfaces (SH).	233	238	253	266
<b>TAKTIK TS16 RTS ERGON-2L</b> 	Office swivel chair with an ERGON 2L mechanism on a black polyamide base (TS16). Upholstered backrest and seat. No armrests (RTS), 50 mm castors for soft surfaces (SH).	212	217	233	245
<b>TAKTIK-MESH TS16 RTS ERGON-2L</b> 	Office swivel chair with ERGON 2L mechanism on a black polyamide base (TS16). Mesh backrest and upholstered seat. No armrests (RTS), 50 mm castors for soft surfaces (SH).	266	269	276	282
<b>TAKTIK-MESH TS16 RTS ERGON-UP</b> 	Office swivel chair with ERGON UP mechanism on a black polyamide base (TS16). Mesh backrest and upholstered seat. No armrests (RTS), 50 mm castors for soft surfaces (SH).	287	290	296	304

TAKTIK

PRICE GROUP 0: Micro, Imitation Leather, Basic fabric  
 PRICE GROUP 1: Oban, Bondai, Lucia, Sempre, Kaiman

PRICE GROUP 2: Microfibra, Contract, Nexus, Valencia, Xtreme, Era

PRICE GROUP 3: Oxygen

TAKTIK MESH

PRICE GROUP 0: Micro, Imitation Leather, Basic fabric  
 PRICE GROUP 1: Oban, Bondai, Lucia, Sempre, Kaiman

PRICE GROUP 2: Microfibra, Contract, Nexus, Valencia, Xtreme

PRICE GROUP 3: Oxygen



TAKTIK SWIVEL CHAIRS

Model	Description	Price group			
		0	1	2	3
<b>TAKTIK-MESH TS16 RTS ACTIV1</b> 	Office swivel chair with ACTIV1 synchro mechanism on a black polyamide base (TS16). Mesh backrest and upholstered seat. No armrests (RTS), 50 mm castors for soft surfaces (SH).	288	292	303	309
<b>TAKTIK-MESH TS16 RTS SFB1</b> 	Office swivel chair with SFB1 self mechanism with automatic weight adjustment on a black polyamide base (TS16). Mesh backrest and upholstered seat. No armrests (RTS), 50 mm castors for soft surfaces (SH).	385	389	400	406
<b>TAKTIK-MESH-U TS16 RTS ERGON-2L</b> 	Office swivel chair with ERGON 2L mechanism on a black polyamide base (TS16). Mesh backrest covered with fabric and upholstered seat. No armrests (RTS), 50 mm castors for soft surfaces (SH).	307	315	331	347
<b>TAKTIK-MESH-U TS16 RTS ERGON-UP</b> 	Office swivel chair with ERGON UP mechanism on a black polyamide base (TS16). Mesh backrest covered with fabric and upholstered seat. No armrests (RTS), 50 mm castors for soft surfaces (SH).	328	336	352	368
<b>TAKTIK-MESH-U TS16 RTS ACTIV1</b> 	Office swivel chair with ACTIV1 synchro mechanism on a black polyamide base (TS16). Mesh backrest covered with fabric and upholstered seat. No armrests (RTS), 50 mm castors for soft surfaces (SH).	330	338	354	369

TAKTIK MESH U

PRICE GROUP 0: Imitation Leather, Basic fabric  
 PRICE GROUP 1: Oban, Bondai, Lucia, Sempre, Kaiman

PRICE GROUP 2: Contract, Nexus, Valencia, Xtreme  
 PRICE GROUP 3: Oxygen

TAKTIK SWIVEL CHAIRS

Model	Description	Price group			
		0	1	2	3
<b>TAKTIK-MESH-U TS16 RTS SFB1</b> 	Office swivel chair with SFB1 self mechanism with automatic weight adjustment on a black polyamide base (TS16). Mesh backrest covered with fabric and upholstered seat. No armrests (RTS), 50 mm castors for soft surfaces (SH).	427	435	451	466
<b>TAKTIK-MESH-ERGO-U TS16 RTS ERGON-2L</b> 	Office swivel chair with ERGON 2L mechanism on a black polyamide base (TS16). Mesh backrest covered with profiled fabric and profiled upholstered seat. No armrests (RTS), 50 mm castors for soft surfaces (SH).	338	346	362	377
<b>TAKTIK-MESH-ERGO-U TS16 RTS ERGON-UP</b> 	Office swivel chair with ERGON UP mechanism on a black polyamide base (TS16). Mesh backrest covered with profiled fabric and profiled upholstered seat. No armrests (RTS), 50 mm castors for soft surfaces (SH).	358	366	382	398
<b>TAKTIK-MESH-ERGO-U TS16 RTS ACTIV1</b> 	Office swivel chair with ACTIV1 synchro mechanism on a black polyamide base (TS16). Mesh backrest covered with profiled fabric and profiled upholstered seat. No armrests (RTS), 50 mm castors for soft surfaces (SH).	360	368	384	400
<b>TAKTIK-MESH-ERGO-U TS16 RTS SFB1</b> 	Office swivel chair with SFB1 self mechanism with automatic weight adjustment on a black polyamide base (TS16). Mesh backrest covered with profiled fabric and profiled upholstered seat. No armrests (RTS), 50 mm castors for soft surfaces (SH).	457	465	481	497











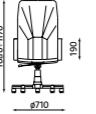

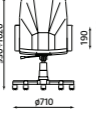

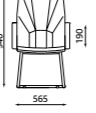
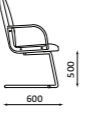

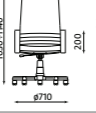

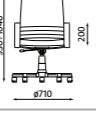

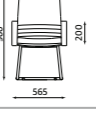

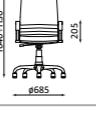

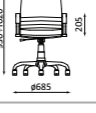

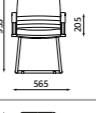
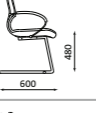
TAKTIK MESH ERGO U

PRICE GROUP 0: Basic fabric  
 PRICE GROUP 1: Oban, Lucia, Sempre

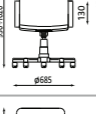
PRICE GROUP 2: Contract, Nexus, Xtreme  
 PRICE GROUP 3: Oxygen

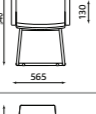
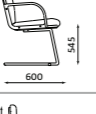
card box diameter [m]	no. of pcs per card box	no. of pcs per EURO pallet	no. of pcs per 1200x1000mm pallet	net weight [kg]	seat of chair - width [mm]	seat of chair - depth [mm]	MODEL [mm]		
							  	<p><b>CHESTER R23P2 steel 28 chrome with an Epron Synchron mechanism</b> CHESTER ST28-POL R23P2-CR-xx ES xx ESH</p>	
0.20	1	8		22	525	470	  	<p><b>CHESTER HRU R23P2 steel 28 chrome with an Epron Synchron mechanism</b> CHESTER-HRU ST28-POL R23P2-CR-xx ES xx ESH</p>	
0.45	1	pallet 1200x800: 4		14.9	525	470	  	<p><b>CHESTER lb cfp chrome</b> CHESTER-LB CFP-CR NF2-xx xx</p>	
0.33	1		8	23.5	520	440	  	<p><b>LINEA steel 04 chrome with a Multiblock mechanism</b> LINEA ST04-POL PF17-CR-xx MPD170 xx SH</p>	
								<p><b>COAT HANGER for LINEA steel chrome</b> CTH</p>	
0.33	1		8	20.2	520	440	  	<p><b>LINEA steel 04 lb chrome with a Multiblock mechanism</b> LINEA-LB ST04-POL PF17-CR-xx MPD170 xx SH</p>	
0.32	1		8	18.7	500	430	  	<p><b>LYNX steel 43 chrome with a Multiblock mechanism</b> LYNX ST43-POL PF40-CR MPD170 xx ESH</p>	
0.32	1		8	18.2	500	435	  	<p><b>LYNX LB steel 43 with a Synchron mechanism</b> LYNX-LB ST43-POL PF40-CR MPD170 xx ESH</p>	
0.32	1		8	16.7	500	435	  	<p><b>LYNX LB steel 48 with a Tilt mechanism</b> LYNX-LB ST48-POL PF40-CR TILT/AR xx GB</p>	
0.54	1	4		16.6	520	470	  	<p><b>LYNX LB CFP</b> LYNX-LB CFP-CR NF-3.097 GB</p>	
0.18	1	10		15.8	520	450	  	<p><b>MANAGER KD ts13 HS with a Tilt mechanism</b> MANAGER-KD TS13 PF18 TILT/C xx SH</p>	
0.18	1	10		14.9	520	450	  	<p><b>MANAGER steel 02 KD with a Tilt mechanism</b> MANAGER-KD ST02-CR PF8 TILT/C xx SH</p>	

PRICE GROUP					
GROUP 0 (M, V, C)	GROUP 1 (BN, YB, EF, SM, KN)	GROUP 2 (YN, CM, UNY, VL, XR)	GROUP 3 (OX, SP FRONT)	GROUP 4 (LE FRONT, SD FRONT, LDS)	GROUP 5 (LE, SD)
only in V 615	only in KN 636	only in CM, VL 668	only in SP FRONT 704	773	879
only in V 671	only in KN 693	only in CM, VL 733	only in SP FRONT 778	856	973
only in V 517	only in KN 533	only in CM, VL 563	only in SP FRONT 595	652	733
only in M, V 611	625	641	670	only in LDS 697	807
49					
only in M, V 579	590	605	627	only in LDS 673	764
only in V 603	only in KN 619	only in CM, VL 637	only in SP FRONT 664	only in LDS 716	844
596	608	621	629	only in LDS 694	824
580	592	605	613	only in LDS 678	793
538	550	561	571	only in LDS 636	751
only in M, V 230	239	253	276		
only in M, V 253	263	277	300		

card box diameter [mm]	no. of pcs per card box	no. of pcs per EURO pallet	no. of pcs per 1200x1000mm pallet	net weight [kg]	seat of chair - width [mm]	seat of chair - depth [mm]	MODEL [mm]		
							  	<p><b>MANAGER ts13</b> with a Tilt mechanism MANAGER TS13 PF6 TILT/C xx SH</p>	
0.29	1	8	8	18.7	505	480	  	<p><b>MANAGER lb ts13</b> with a Tilt mechanism MANAGER-LB TS13 PF6 TILT/C xx SH</p>	
0.29	1	8	8	15.8	505	480	  	<p><b>MANAGER cf lb black</b> MANAGER-LB CF-BL PF6 xx</p>	
0.29	1	8	8	16.3	500	510	  	<p><b>MIRAGE ts13</b> with a Tilt mechanism MIRAGE TS13 PF12 TILT/C xx SH</p>	
0.26	1	8	8	14.5	500	510	  	<p><b>MIRAGE lb ts13</b> with a Tilt mechanism MIRAGE-LB TS13 PF12 TILT/C XX SH</p>	
0.29	1	8	8	13.2	500	510	  	<p><b>MIRAGE cf lb black</b> MIRAGE-LB CF-BL PF12 xx</p>	
0.29	1	8	8	21.4	500	510	  	<p><b>MIRAGE steel 02 chrome</b> with a Tilt mechanism MIRAGE ST02-CR PF31-CR-xx TILT/C xx SH</p>	
0.26	1	8	8	17.8	500	510	  	<p><b>MIRAGE steel 02 lb chrome</b> with a Tilt mechanism MIRAGE-LB ST02-CR PF31-CR-xx TILT/C xx SH</p>	
0.29	1	8	8	13.2	500	510	  	<p><b>MIRAGE steel cf lb chrome</b> MIRAGE-LB CF-CR PF31-CR-xx xx</p>	
0.29	1	8	8	19.4	505	470	  	<p><b>NADIR ts13</b> with a Tilt mechanism NADIR TS13 PF6 TILT/C xx SH</p>	
0.26	1	8	8	17.7	505	470	  	<p><b>NADIR lb ts13</b> with a Tilt mechanism NADIR-LB TS13 PF6 TILT/C xx SH</p>	
0.29	1	8	8	16.8	505	470	  	<p><b>NADIR cf lb black</b> NADIR-LB CF-BL PF6 xx</p>	
0.29	1	8	8	19.4	510	480	  	<p><b>NADIR steel 02 chrome</b> with a Tilt mechanism NADIR ST02-CR PF27-CR-xx TILT/C xx SH</p>	

GROUP 0 (M, V, C)	PRICE GROUP				
	GROUP 1 (BN, YB, EF, SM, KN)	GROUP 2 (YN, CM, UNY, VL, XR)	GROUP 3 (OX, SP FRONT)	GROUP 4 (LE FRONT, SD FRONT, LDS)	GROUP 5 (LE, SD)
only in M, V 301	310	325	347		
only in M, V 287	295	307	326		
only in M, V 279	286	298	317		
only in M, V 298	only in YB, EF, SM, KN 309	321	342		
only in M, V 286	only in YB, EF, SM, KN 295	307	322		
only in M, V 272	only in YB, EF, SM, KN 282	293	309		
only in M, V 344	only in YB, EF, SM, KN 355	368	388		
only in M, V 332	only in YB, EF, SM, KN 341	353	369		
only in M, V 298	only in YB, EF, SM, KN 307	318	334		
only in M, V 320	331	344	361		
only in M, V 294	305	318	337		
only in M, V 379	390	404	423		
only in M, V 341	352	366	382		

card box diameter [mm]	no. of pcs per card box	no. of pcs per EURO pallet	no. of pcs per 1200x1000mm pallet	net weight [kg]	seat of chair - width [mm]	seat of chair - depth [mm]	MODEL [mm]	
0.26	1	8	8	17.7	510	480	 <b>NADIR steel 02 lb chrome with a Tilt mechanism</b> NADIR-LB ST02-CR PF27-CR-xx TILT/C xx	
0.29	1	8	8	16.8	510	480	 <b>NADIR steel cf lb chrome</b> NADIR-LB CF-CR PF27-CR-xx xx	
<b>Neo-Lux</b>								
0.33	1	8	8	22.3	520	470	 <b>NOVA steel 04 alu with a Multiblock mechanism</b> NOVA ST04-ALU PF5-ALU-xx MPD170 xx SH	
							 <b>NOVA steel 04 chrome with a Multiblock mechanism</b> NOVA ST04-POL PF5-CR-xx MPD170 xx SH	
							 <b>COAT HANGER for NOVA steel alu and chrome</b> CTH	
0.33	1	8	8	20.9	520	470	 <b>NOVA steel 04 lb alu with a Multiblock mechanism</b> NOVA-LB ST04-ALU PF5-ALU-xx MPD170 xx SH	
							 <b>NOVA steel 04 lb chrome with a Multiblock mechanism</b> NOVA-LB ST04-POL PF5-CR-xx MPD170 xx SH	
0.33	1	8	8	15.5	520	470	 <b>NOVA steel cf lb alu</b> NOVA-LB CF-ALU PF5-ALU-xx xx	
							 <b>NOVA steel cf lb chrome</b> NOVA-LB CF-CR PF5-CR-xx xx	
0.33	1	8	8	23.3	500	490	 <b>ORION steel 04 alu with a Multiblock mechanism</b> ORION ST04-ALU PF5-ALU-xx MPD170 xx SH	
							 <b>ORION steel 04 chrome with a Multiblock mechanism</b> ORION ST04-POL PF5-CR-xx MPD170 xx SH	
							 <b>COAT HANGER for ORION steel alu and chrome</b> CTH	
0.33	1	8	8	22.5	500	490	 <b>ORION steel 04 lb alu with a Multiblock mechanism</b> ORION-LB ST04-ALU PF5-ALU-xx MPD170 xx SH	
							 <b>ORION steel 04 lb chrome with a Multiblock mechanism</b> ORION-LB ST04-POL PF5-CR-xx MPD170 xx SH	
0.33	1	8	8	17.9	500	490	 <b>ORION steel cf lb alu</b> ORION-LB CF-ALU PF5-ALU-xx xx	
							 <b>ORION steel cf lb chrome</b> ORION-LB CF-CR PF5-CR-xx xx	

PRICE GROUP					
GROUP 0 (M, V, C)	GROUP 1 (BN, YB, EF, SM, KN)	GROUP 2 (YN, CM, UNY, VL, XR)	GROUP 3 (OX, SP FRONT)	GROUP 4 (LE FRONT, SD FRONT, LDS)	GROUP 5 (LE, SD)
only in M, V 357	369	381	399		
only in M, V 347	358	371	388		
Prices on page 42					
only in M, V 598	only in SM, KN 610	only in YN, CM, UNY, VL 632	659	only in LDS 714	800
only in M, V 617	only in SM, KN 629	only in YN, CM, UNY, VL 651	678	only in LDS 734	819
49					
only in M, V 587	only in SM, KN 597	only in YN, CM, UNY, VL 617	640	only in LDS 686	759
only in M, V 595	only in SM, KN 605	only in YN, CM, UNY, VL 625	648	only in LDS 694	767
only in M, V 417	only in SM, KN 427	only in YN, CM, UNY, VL 447	470	only in LDS 516	589
only in M, V 425	only in SM, KN 435	only in YN, CM, UNY, VL 455	478	only in LDS 524	597
only in V 586	only in KN 598	only in CM, VL 622	only in SP FRONT 648	only in LDS 702	859
only in V 594	only in KN 606	only in CM, VL 630	only in SP FRONT 656	only in LDS 710	867
49					
only in V 570	only in KN 581	only in CM, VL 602	only in SP FRONT 627	only in LDS 670	800
only in V 578	only in KN 589	only in CM, VL 610	only in SP FRONT 635	only in LDS 678	808
only in V 422	only in KN 433	only in CM, VL 454	only in SP FRONT 479	only in LDS 522	652
only in V 430	only in KN 441	only in CM, VL 462	only in SP FRONT 487	only in LDS 530	660

# Orlando

# Orlando



## OPTIONS FOR ORLANDO

Additional equipment/information	Symbol	Extra charge
Height adjustable armrests	<b>R16H-CR</b>	65
Seat depth adjustment mechanism	<b>EST</b>	24
Seat depth adjustment and negative seat inclination mechanism	<b>EFT</b>	83
Upholstered armrests with black Imitation Leather (applicable to CFP version only)	<b>NF9-V14N</b>	5
50 mm castors for hard surfaces	<b>SHH</b>	without extra charge
65 mm castors for hard surfaces	<b>ESHH</b>	without extra charge
Felt glides for hard surfaces (applicable to CFP version)	<b>GBF</b>	8

Apart from the product number/code, please specify option symbol, fabric and finish codes to complete an order.

## ORLANDO CHAIRS

Model	Description	Versions	Price group				
			1	2	3	4	5
<b>ORLANDO ES</b> 	Swivel chair with a synchro mechanism (ES) on a polished aluminum base (ST28-POL). Upholstered backrest and seat. No armrests, 50 mm castors for soft surfaces.	Chromium version	363	404	422	481	527
<b>ORLANDO-UP ES</b> 	Swivel chair with a synchro mechanism (ES) on a polished aluminum base (ST28-POL). Adjustable upholstered backrest and upholstered seat. No armrests, 50 mm castors for soft surfaces.	Chromium version	408	449	466	525	571
<b>ORLANDO-HB ES</b> 	Swivel chair with a synchro mechanism (ES) on a polished aluminum base (ST28-POL). High upholstered backrest and upholstered seat. No armrests, 50 mm castors for soft surfaces.	Chromium version	389	435	451	520	569
<b>ORLANDO WOOD CFP</b> 	Visitor chair on a cantilever frame, chromium plated. Armrests with wooden pads. Plastic glides for soft surfaces.	Chromium version	431	472	490	548	595

PRICE GROUP 1: Bondai, Sempre, Kaiman, Oban  
 PRICE GROUP 2: Contract, Microfibra, Nexus, Valencia, Xtreme

PRICE GROUP 3: King L Elast, Oxygen, Silvertex, Flex  
 PRICE GROUP 4: Blazer, Fame, LE leather front, SD leather front

PRICE GROUP 5: Fine Leather LE, Fine Leather SD, Fine Leather Q



OPTIONS FOR NEO-LUX

Additional equipment/information	Symbol	Extra charge
Chromed coat hanger (not applicable to Neo-Lux Net and visitor versions)	<b>CTH</b>	49
50 mm castors for hard floors	<b>SHH</b>	without extra charge
Fixed armrests for cantilever frame, powder coated metal elements	<b>GTP9-ALU</b>	30
Fixed armrests for cantilever frame, chromium plated metal elements	<b>GTP9-CR</b>	41

NEO-LUX CHAIRS

Model	Description	Versions	Price group				
			1	2	3	4	5
<b>NEO-LUX MPD165</b> 	Swivel chair with a synchro mechanism (MPD 165). High upholstered backrest and an upholstered seat. Height adjustable armrests (R1B) with PU pads. 50 mm castors for soft floors. Aluminum base, powder coated in RAL 9006 (ST 04-ALU).		519	548	587	627	711
		ST 04-POL (chromium version)	8				
<b>NEO-LUX-LB MPD165</b> 	Swivel chair with a synchro mechanism (MPD 165). Low upholstered backrest and an upholstered seat. Height adjustable armrests (R1B) with PU pads. 50 mm castors for soft floors. Aluminum base, powder coated in RAL 9006 (ST 04-ALU).		501	528	551	584	649
		ST 04-POL (chromium version)	8				
<b>NEO-LUX NET MPD165</b> 	Swivel chair with a synchro mechanism (MPD 165). Low mesh backrest and an upholstered seat. Height adjustable armrests (R1B) with PU pads. 50 mm castors for soft floors. Aluminum base, powder coated in RAL 9006 (ST 04-ALU).		497	513	530	549	608
		ST 04-POL (chromium version)	8				
<b>NEO-LUX-LB CF</b> 	Visitor cantilever chair, without armrests. Upholstered backrest and seat. Glides for soft floors. Frame powder coated in RAL 9006.		318	343	367	399	464
		Chromium version	326	351	375	407	472
<b>NEO-LUX-LB NET CF</b> 	Visitor cantilever chair, without armrests. Mesh backrest and upholstered seat. Glides for soft floors. Frame powder coated in RAL 9006.		313	329	345	365	424
		Chromium version	321	337	353	373	432
<b>NEO-LUX 4L-ARM</b> 	Visitor 4-leg chair with armrests, chromium plated. Mesh backrest and upholstered seat. Glides for soft floors. Frame powder coated in RAL 9006.		341	369	391	424	489
		Chromium version	349	376	399	432	497

PRICE GROUP 1: Sempre, Kaiman, Oban  
 PRICE GROUP 2: Contract, Nexus, Valencia, Xtreme

PRICE GROUP 3: Oxygen, Silvertex, Flex, Split Leather SP front  
 PRICE GROUP 4: Blazer, Fame, LE leather front, SD leather front

PRICE GROUP 5: Fine Leather LE, Fine Leather SD, Fine Leather Q



OPTIONS FOR NEXT\_U

Additional equipment/information	Symbol	Extra charge
Fixed armrests with polished aluminum metal elements and upholstered armpads (applicable to swivel versions only)	<b>GTP38-CR</b>	122
2-D armrests with polished aluminum metal elements and upholstered armpads (applicable to swivel versions only)	<b>R23-P1</b>	122
Seat depth adjustment mechanism	<b>ESPT</b>	37
65mm castors for hard surfaces	<b>ESHH</b>	without extra charge

Apart from the product number/code, please specify option symbol, fabric and finish codes to complete an order.

NEXT\_U CHAIRS

Model	Description	Versions	Price group				
			1	2	3	4	5
<p><b>NEXT_U ESP</b></p>	Swivel chair with a synchro mechanism (ESP) on a chromed steel base (ST29-CR). High upholstered backrest and an upholstered seat. No armrests, selfbraking castors Ø 65 for soft surfaces.	Chromium version	571	591	610	649	711
<p><b>NEXT_U HRUA ESP</b></p>	Swivel chair with a synchro mechanism (ESP) on a chromed steel base (ST29-CR). High upholstered backrest with an upholstered, adjustable headrest and an upholstered seat. No armrests, selfbraking castors Ø 65 for soft surfaces.	Chromium version	599	625	650	692	761
<p><b>NEXT_U-LB CF GTP38</b></p>	Visitor cantilever chair, chromium plated frame with armrests, upholstered pads. Upholstered backrest and seat.	Chromium version	612	631	649	680	711

PRICE GROUP 1: Lucia, Sempre, Kaiman  
PRICE GROUP 2: Contract, Valencia, Xtreme

PRICE GROUP 3: Oxygen, Split Leather SP front  
PRICE GROUP 4: Blazer, Fame, LE Leather front, SD Leather front

PRICE GROUP 5: Fine Leather LE, Fine Leather SD, Fine Leather Q





OPTIONS FOR SONATA

Additional equipment/information	Symbol	Extra charge
Chromed coat hanger (for swivel versions)	<b>CTH</b>	49
65 mm castors for hard surfaces	<b>ESHH</b>	without extra charge

Apart from the product number/code, please specify option symbol, fabric and finish codes to complete an order.

SONATA CHAIRS

Model	Description	Versions	Price group				
			1	2	3	4	5
<p><b>SONATA-LUX HRUA MPD170</b></p>	Swivel chair with a synchro mechanism (MPD170) on a polished aluminum base (ST28-POL). High upholstered backrest with an upholstered, adjustable headrest and an upholstered seat. Fixed chrome armrests with upholstered pads. Selfbraking 65 mm castors for soft surfaces.	Chromium version	650	712	747	826	904
<p><b>SONATA-LUX HRU MPD170</b></p>	Swivel chair with a synchro mechanism (MPD170) on a polished aluminum base (ST28-POL). High upholstered backrest with an upholstered headrest and an upholstered seat. Fixed chrome armrests with upholstered pads. Selfbraking 65 mm castors for soft surfaces.	Chromium version	585	644	674	744	826
<p><b>SONATA-LUX HRUA ES</b></p>	Swivel chair with a synchro mechanism (ES) on a polished aluminum base (ST28-POL). High upholstered backrest with an upholstered, adjustable headrest and an upholstered seat. 2-D armrests with upholstered armpads, chromium plated metal elements (R15-CR). Selfbraking 65 mm castors for soft surfaces.	Chromium version	650	712	747	826	904
<p><b>SONATA-LUX HRU ES</b></p>	Swivel chair with a synchro mechanism (ES) on a polished aluminum base (ST28-POL). High upholstered backrest with an upholstered headrest and an upholstered seat. 2-D armrests with upholstered armpads, chromium plated metal elements (R15-CR). Selfbraking 65 mm castors for soft surfaces.	Chromium version	680	644	674	744	826
<p><b>SONATA-LUX CFP</b></p>	Visitor cantilever chair, chromium plated frame, with armrests, upholstered pads. Upholstered backrest and seat.	Chromium version	505	553	578	644	726

PRICE GROUP 1: Bondai, Lucia, Sempre, Kaiman, Oban  
 PRICE GROUP 2: Contract, Microfibra, Nexus, Valencia, Xtreme

PRICE GROUP 3: King L Elast, Oxygen, Silvertex, Flex, Split Leather SP front  
 PRICE GROUP 4: Blazer, Fame, LE Leather front, SD Leather front

PRICE GROUP 5: Fine Leather LE, Fine Leather SD, Fine Leather Q

EXECUTIVE ARMCHAIRS	MECHANISMS			
	TILT	MULTIBLOCK	EPRON SYNCRON	DUETTO
CHESTER			•	
LINEA		•		
LYNX	•	•	•	
MANAGER	•			
MIRAGE	•			
NADIR	•			
NEO-LUX				•
NOVA		•		
ORION		•		
ORLANDO			•	
SONATA		•	•	

OFFICE CHAIRS	MECHANISMS													
	CPT	ERGON UP	ERGON 2L	TILT	ACTIV1	EPRON SYNCRON	EPRON SYNCRON PLUS	FS	IMARC670	DUETTO	IBRA	SYNCRON	SFB1	LP 11
@-SENSE								•						•
AIRGO	•				•									
CINQUE					•									
ENJOY												•		
FLEX					•									
GEM					•									
I-LINE			•											
JUPITER	•													
MADAME				•										
MASTER	•				•				•					
MONTANA						•	•							
NEO II				•		•				•				
OFFICER-NET						•								
OFFIX											•			
PEGAZ	•													
PRESTIGE	•													
PUNKT			•											
QUATRO					•									
SATURN	•													
SIT.NET						•								
SIT.ON						•								
SMART	•													
TAKTIK		•	•		•	•							•	
WEBST@R	•													

## CASTORS



SHH



ESHH

**Self-braking castors designed for parquets and hard surfaces** – hard, plastic castors covered with a thin rubber, protecting the parquets, panel surfaces, stone surfaces on which the chair moves from scratching. Under the pressure of a chair user castors start moving freely. After a user's raising from a chair, the castors block automatically. The self-braking mechanism is within the castor. Available in two sizes: Ø50 and Ø65.













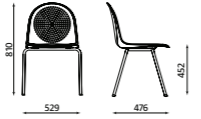
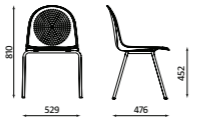

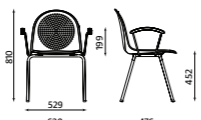
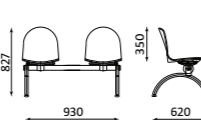

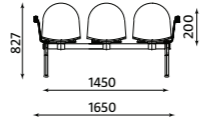
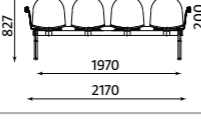
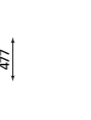
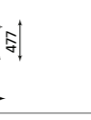
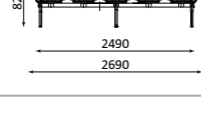

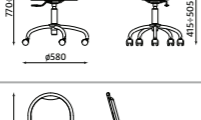

SH

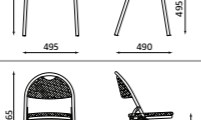

ESH

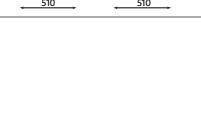
**Self-braking castors designed for carpeted surfaces** – hard, plastic castors, easily moving on soft surfaces, like carpets and other types of carpeted surfaces. Under the pressure of a chair user castors start moving freely. After a user's raising from a chair, the castors block automatically. The selfbraking mechanism is within the castor. Available in two sizes: Ø50 and Ø65.

# CONFERENCE AND VISITOR CHAIRS

stacking max. no of pcs	card box diameter [m <sup>2</sup> ]	no. of pcs per card box	no. of pcs per EURO pallet	no. of pcs per 1200x1000 mm pallet	net weight [kg]	chair seat - width [mm]	chair seat - depth [mm]	MODEL [mm]	
8	0.34	4		32	4.3	460	460	   	<b>AMIGO alu</b> AMIGO 4L-ALU xx GB <b>AMIGO chrome</b> AMIGO 4L-CR xx GB
8	0.34	4		32	4.8	460	460	   	<b>AMIGO click alu</b> AMIGO-CLICK 4L-ALU xx GB <b>AMIGO click chrome</b> AMIGO-CLICK 4L-CR xx GB
8	0.34	4		32	5.7	460	460	   	<b>AMIGO ARM alu</b> AMIGO 4L-ALU ARM-ALU-xx xx GB <b>AMIGO ARM chrome</b> AMIGO 4L-CR ARM-CR-xx xx GB
0.16	1	10			23	460	460	 	<b>AMIGO ARM-2 alu</b> AMIGO-2 A-ALU ARM-ALU-xx xx GB
0.18	1	10			27	460	460	 	<b>AMIGO ARM-3 alu</b> AMIGO-3 A-ALU ARM-ALU-xx xx GB
0.21	1	8			35	460	460	 	<b>AMIGO ARM-4 alu</b> AMIGO-4 A-ALU ARM-ALU-xx xx GB
0.21	1	8			43	460	460	 	<b>AMIGO ARM-5 alu</b> AMIGO-5 A-ALU ARM-ALU-xx xx GB
									<b>AMIGO CONNECTOR</b> to connect benches 2 pcs in a set
0.12	1	14			8.8	460	460	 	<b>AMIGO gtp chrome</b> AMIGO ST20-CR GTP54-CR-xx PST00 xx SH
6	0.34	4		32	7.1	400	450	 	<b>ARIOSO alu &amp; bl</b> ARIOSO 4L-zz xx GB
6	0.34	4		50	5.8	400	450	 	<b>ARIOSO FOLD alu &amp; bl</b> ARIOSO-FOLD 4L-zz xx GB
6	0.34	4		50	5.8	400	450		<b>ARIOSO FOLD click</b> ARIOSO-FOLD 4L-zz xx GB

Price Group							
PLYWOOD	LAMINATE	GROUP 0 (M, V, C)	GROUP 1 (BN, YB, EF, SM, KN)	GROUP 2 (YN, CM, UNY, VL, XR, CSE)	GROUP 3 (OX, SP FRONT, RN)	GROUP 4 (LE FRONT, SD FRONT, LDS)	GROUP 5 (LE, SD)
				PLASTIC 77			
				PLASTIC 82			
				PLASTIC 91			
				PLASTIC 102			
				PLASTIC 99			
				PLASTIC 109			
				PLASTIC 294			
				PLASTIC 354			
				PLASTIC 413			
				PLASTIC 515			
				5			
				PLASTIC 92			
		85	86	91			
		121	123	126			
		134	136	139			

# CONFERENCE AND VISITOR CHAIRS

stacking max. no of pcs	card box diameter [mm]	no. of pcs per card box	no. of pcs per EURO pallet	no. of pcs per 1200×1000 mm pallet	net weight [kg]	chair seat - width [mm]	chair seat - depth [mm]	MODEL [mm]	
<b>3 YEARS WARRANTY</b>									
<b>Universal row linking system for conference chairs</b>									
6			pallet 1150×1100: 72		3.2	440	400		<b>BETA chrome</b> BETA-NSN 4L-CR xx GB
6			pallet 1150×1100: 72		4	440	400		<b>BETA plus chrome</b> BETA-NSN 4L-CR PLUS-xx-xx GB
6			pallet 1150×1100: 72		3.2	440	400		<b>BETA click chrome</b> BETA-NSN-CLICK 4L-CR xx GB
6			pallet 1150×1100: 72		4	440	400		<b>BETA click plus chrome</b> BETA-NSN-CLICK 4L-CR PLUS-xx-xx GB
0.48	4	16			4.1	440	400		<b>BETA TL chrome</b> BETA-NSN 4L-CR xx TL GB
									<b>BETA TR chrome</b> BETA-NSN 4L-CR xx TR GB
0.48	4	16			4.9	440	400		<b>BETA plus TL chrome</b> BETA-NSN 4L-CR PLUS-xx-xx TL GB
									<b>BETA plus TR chrome</b> BETA-NSN 4L-CR PLUS-xx-xx TR GB
6			pallet 1200×800: 20		4.2	430	400		<b>BETA cfs chrome</b> BETA-NSN CFS-CR XX GB
0.15	1	pallet 1200×800: 10			19.5	440	400		<b>BETA-3 black</b> BETA-3-NSN B-BL xx GB
0.18	1	pallet 1200×800: 8			24.5	440	400		<b>BETA-4 black</b> BETA-4-NSN B-BL xx GB
0.21	1	pallet 1200×800: 8			30.7	440	400		<b>BETA-5 black</b> BETA-5-NSN B-BL xx GB
<b>Universal row linking system for conference chairs</b>									

Price Group							
PLYWOOD	LAMINATE	GROUP 0 (M, V, C)	GROUP 1 (BN, YB, EF, SM, KN)	GROUP 2 (YN, CM, UNY, VL, XR, CSE)	GROUP 3 (OX, SP FRONT, RN)	GROUP 4 (LE FRONT, SD FRONT, LDS)	GROUP 5 (LE, SD)

Pricing upon the request





PLASTIC 46							
		65	70	71			
PLASTIC 52							
		71	76	78			
PLASTIC 98							
PLASTIC 98							
		114	120	122			
		114	120	122			
PLASTIC 76							
PLASTIC 223							
PLASTIC 274							
PLASTIC 338							
Pricing upon the request							

# CONFERENCE AND VISITOR CHAIRS

stacking max. no of pcs	card box diameter [m]	no. of pcs per card box	no. of pcs per EURO pallet	no. of pcs per 1200x1000 mm pallet	net weight [kg]	chair seat - width [mm]	chair seat - depth [mm]	MODEL [mm]	
4	0.36	2	pallet 1200x1200: 16		7.2	460	380	 <b>CINQUE 4L ARM alu&amp;bl</b> CINQUE-SQUARE 4L-ARM-zz xx GB	 <b>CINQUE 4L ARM chrome</b> CINQUE-SQUARE 4L-ARM-CR xx GB
0.38	1	6			16	480	500	 <b>CLUB</b> CLUB xx	
0.38	1	6			17.2	480	480	 <b>CLUB TR-xx</b> CLUB TR-xx xx	
0.68	1	3			28.6	1066	500	 <b>CLUB DUO</b> CLUB-DUO xx	
0.93	1	pallet 800x1700: 3			38	1570	500	 <b>CLUB TRIO</b> CLUB-TRIO-420 xx	
0.37	1	6			16	480	480	 <b>CLUB ROLL</b> CLUB-ROLL xx	
0.38	1	4			18.7	480	500	 <b>CLUB SQ</b> CLUB-SQ xx	
0.43	1	4			19.9	480	500	 <b>CLUB SQ TR-xx</b> CLUB-SQ-TR-xx xx	
0.68	1	3			28.6	1030	500	 <b>CLUB SQ DUO</b> CLUB-SQ-DUO xx	
0.8	1	6			16.3	480	480	 <b>COLUMBIA</b> COLUMBIA xx	
0.68	1	3			18	1060	480	 <b>COLUMBIA DUO</b> COLUMBIA-DUO xx	
4	0.36	3	12	18 or 21	6.7	470	470	 <b>ELVA</b> ELVA 4L-ARM-xx xx	

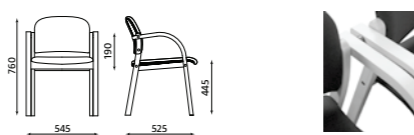
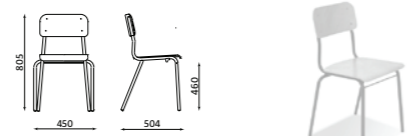
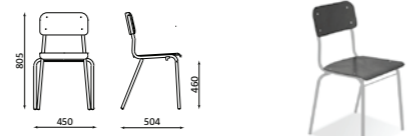
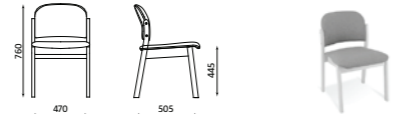
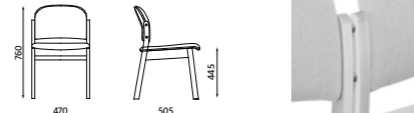
Price Group							
PLYWOOD	LAMINATE	GROUP 0 (M, V, C)	GROUP 1 (BN, YB, EF, SM, KN)	GROUP 2 (YN, CM, UNY, VL, XR, CSE)	GROUP 3 (OX, SP FRONT, RN)	GROUP 4 (LE FRONT, SD FRONT, LDS)	GROUP 5 (LE, SD)
		only in M 231	only in EF, BN, YB 238	only in YN, UNY, XR, CSE 252	only in OX 260		
		only in M 255	only in EF, BN, YB 261	only in YN, UNY, XR, CSE 272	only in OX 280		
		only in V 298	only in EF, SM 315	only in YN, UNY, VL, XR 365	in OX, SP FRONT, SX, K 376	in LE FRONT, SD FRONT, F, CUZ, LDS 425	in LE, SD, Q 557
		only in V 334	only in EF, SM 352	only in YN, UNY, VL, XR 401	in OX, SP FRONT, SX, K 412	in LE FRONT, SD FRONT, F, CUZ, LDS 462	in LE, SD, Q 594
		only in V 514	only in EF, SM 525	only in YN, UNY, VL, XR 611	in OX, SP FRONT, SX, K 641	in LE FRONT, SD FRONT, F, CUZ, LDS 721	in LE, SD, Q 1055
		only in V 708	only in EF, SM 741	only in YN, UNY, VL, XR 862	in OX, SP FRONT, SX, K 905	in LE FRONT, SD FRONT, F, CUZ, LDS 1032	in LE, SD, Q 1263
		only in V 313	only in EF, SM 330	only in YN, UNY, VL, XR 379	in OX, SP FRONT, SX, K 390	in LE FRONT, SD FRONT, F, CUZ, LDS 440	in LE, SD, Q 572
		only in V 354	only in EF, SM 366	only in YN, UNY, VL, XR 424	in OX, SP FRONT, SX 447	in LE FRONT, SD FRONT, F, CUZ, LDS 476	in LE, SD, Q 619
		only in V 404	only in EF, SM 417	only in YN, UNY, VL, XR 474	in OX, SP FRONT, SX 498	in LE FRONT, SD FRONT, F, CUZ, LDS 686	in LE, SD, Q 829
		only in V 560	only in EF, SM 571	only in YN, UNY, VL, XR 657	in OX, SP FRONT, SX 687	in LE FRONT, SD FRONT, F, CUZ, LDS 767	in LE, SD, Q 958
		only in M, V 418	only in EF, SM, KN 434	only in YN, UNY, VL, XR, CSE 499	only in OX, SP FRONT 515	630	892
		only in M, V 668	only in EF, SM, KN 717	only in YN, UNY, VL, XR, CSE 782	only in OX, SP FRONT 816	930	1372
		208	211	228	only in OX 239		

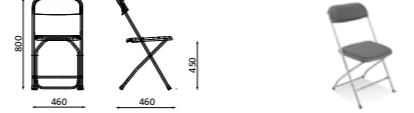
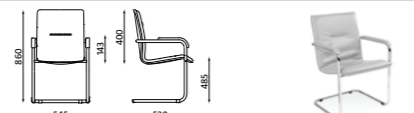
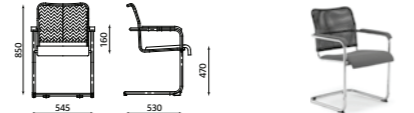
# CONFERENCE AND VISITOR CHAIRS

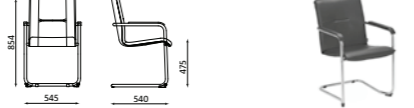
stacking max. no of pcs	card box diameter [m <sup>2</sup> ]	no. of pcs per card box	no. of pcs per EURO pallet	no. of pcs per 1200×1200 mm pallet	net weight [kg]	chair seat - width [mm]	chair seat - depth [mm]	MODEL [mm]	3 YEARS WARRANTY
4	0.37	3	12		6.7	470	470	 <b>ELVA click</b> ELVA-CLICK 4L-ARM-xx xx	
<b>ISO</b>									
4	0.35	4	pallet 1200×1200: 32		3.9	370	410	 <b>IRYS alu</b> IRYS 4L-ALU WOOD-xx GB	
<b>IRYS chrome</b> IRYS 4L-CR WOOD-xx GB									
4	0.35	4	pallet 1200×1200: 32		3.9	370	410	 <b>IRYS alu</b> IRYS 4L-ALU LAMINATE-xx GB	
<b>IRYS chrome</b> IRYS 4L-CR LAMINATE-xx GB									
4	0.38	4	16		6.3	480	470	 <b>MALVA</b> MALVA 4L-xx xx	
4	0.38	4	16		6.3	480	470	 <b>MALVA click</b> MALVA-CLICK 4L-xx xx	
20 after folding	0.09	5		120	3	400	400	 <b>POLYFOLD alu &amp; bl</b> POLYFOLD 4L-zz xx GB	
20 after folding	0.09	5		100	4.8	400	400	 <b>POLYFOLD plus alu &amp; bl</b> POLYFOLD 4L-zz PLUS-xx-xx GB	
<b>POLYFOLD click alu &amp; bl</b> POLYFOLD-CLICK 4L-zz xx GB									
<b>POLYFOLD click plus alu &amp; bl</b> POLYFOLD-CLICK 4L-zz PLUS-xx-xx GB									
0.44	2		12		7.5	490	430	 <b>RUMBA</b> RUMBA CFP-CR NF-xx xx GB	
0.44	2		12		9.2	490	430	 <b>RUMBA NET</b>  * RUMBA-NET CFP-CR NF-xx BA-xx SE-xx GB	
4	0.51	4	16		8.3	555		 <b>RUMBA S</b> RUMBA-S CFP-CR NF-xx xx GB	

\*  The chairs are not to be sold in Germany, Switzerland and Benelux.











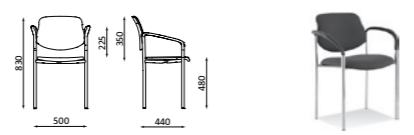

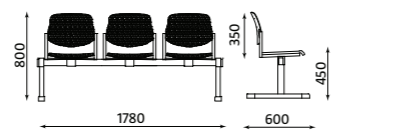
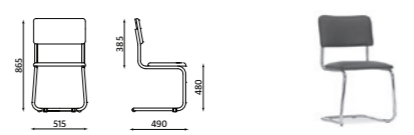
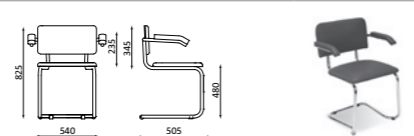
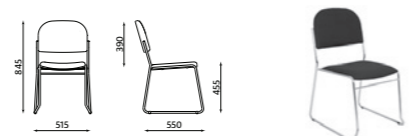
Price Group							
PLYWOOD	LAMINATE	GROUP 0 (M, V, C)	GROUP 1 (BN, YB, EF, SM, KN)	GROUP 2 (YN, CM, UNY, VL, XR, CSE)	GROUP 3 (OX, SP FRONT, RN)	GROUP 4 (LE FRONT, SD FRONT, LDS)	GROUP 5 (LE, SD)
		218	221	239	only in OX 251		
Prices on page 64							
95							
100							
	105						
	111						
		194	197	210	only in OX 221		
		204	207	220	only in OX 231		
PLASTIC 45							
		67					
PLASTIC 51							
		74					
		185	189	193			
		230	233	238			
		159	162	167			

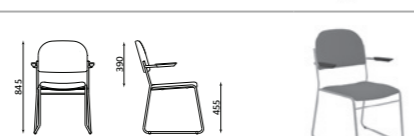
# CONFERENCE AND VISITOR CHAIRS

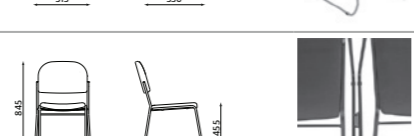
stacking max. no of pcs	card box diameter [mm]	no. of pcs per card box	no. of pcs per EURO pallet	no. of pcs per 1200x1000 mm pallet	net weight [kg]	chair seat - width [mm]	chair seat - depth [mm]	MODEL [mm]	3 YEARS WARRANTY	
4	0.36	2	16	8	460	460		<b>SAMBA alu</b> SAMBA 4L-ARM-ALU NF-xx xx GB		
								<b>SAMBA chrome</b> SAMBA 4L-ARM-CR NF-xx xx GB		
	0.34	1	6	8	9.3	460		<b>SAMBA TR-xx alu</b> SAMBA 4L-ARM-ALU NF-xx xx TR-xx GB		
								<b>SAMBA TR-xx chrome</b> SAMBA 4L-ARM-CR NF-xx xx TR-xx GB		
4	0.36	2	16	7.8	445	460		<b>SAMBA wood alu</b> SAMBA 4L-ARM-ALU NF-xx WOOD-xx GB		
								<b>SAMBA wood chrome</b> SAMBA 4L-ARM-CR NF-xx WOOD-xx GB		
	0.36	1	6	8	8	445		<b>SAMBA wood TR-xx alu</b> SAMBA 4L-ARM-ALU NF-xx WOOD-xx TR-xx GB		
								<b>SAMBA wood TR-xx chrome</b> SAMBA 4L-ARM-CR NF-xx WOOD-xx TR-xx GB		
4	0.36	2	6	16	7.8	445		<b>SAMBA wood plus alu</b> SAMBA 4L-ARM-ALU NF-xx PLUS-xx-xx GB		
								<b>SAMBA wood plus chrome</b> SAMBA 4L-ARM-CR NF-xx PLUS-xx-xx GB		
	0.34	1	6	8	8.8	445		<b>SAMBA wood plus TR-xx alu</b> SAMBA 4L-ARM-ALU NF-xx PLUS-xx-xx TR-xx GB		
								<b>SAMBA wood plus TR-xx chrome</b> SAMBA 4L-ARM-CR NF-xx PLUS-xx-xx TR-xx GB		
4	0.36	2	16	8	445	460		<b>SAMBA NET alu</b> SAMBA-NET 4L-ARM-ALU NF-xx BA-xx SE-xx GB		
								<b>SAMBA NET chrome</b> SAMBA-NET 4L-ARM-CR NF-xx BA-xx SE-xx GB		
	0.21	1	8		10	465	480		<b>SAMBA II gtp</b> SAMBA-II ST01-CR GTP-CR-xx PST45-BL xx SH	
6	0.4	4	pallet 1200x1200: 32	5.5	450	460		<b>STYL alu &amp; bl</b> STYL 4L-zz xx GB		
								<b>STYL chrome</b> STYL 4L-CR xx GB		

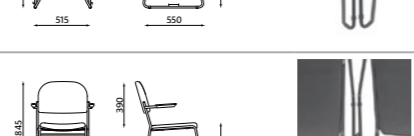
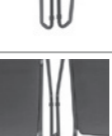
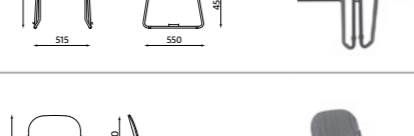
PLYWOOD	LAMINATE	Price Group						
		GROUP 0 (M, V, C)	GROUP 1 (BN, YB, EF, SM, KN)	GROUP 2 (YN, CM, UNY, VL, XR, CSE)	GROUP 3 (OX, SP FRONT, RN)	GROUP 4 (LE FRONT, SD FRONT, LDS)	GROUP 5 (LE, SD)	
		163	166	190	96	99	265	
		171	174	198	212	217	272	
		258	261	285	299	304	165	
		266	269	293	307	312	368	
203								
210								
300								
308								
		236	239	263	277			
		245	249	272	287			
		328	331	339	353			
		336	339	363	377			
		201	204	210	226			
		209	212	218	234			
								6
		260	264	287	302	307	362	
		87	92	95				
		92	97	100				

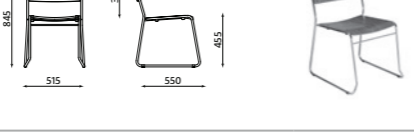







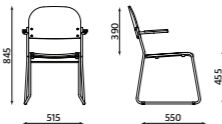

# CONFERENCE AND VISITOR CHAIRS

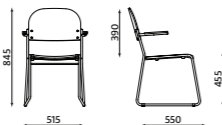
stacking max. no of pcs	card box diameter [mm]	no. of pcs per card box	no. of pcs per EURO pallet	no. of pcs per 1200x1000 mm pallet	net weight [kg]	chair seat - width [mm]	chair seat - depth [mm]	MODEL [mm]	
6	0.4	4	16		6.9	450	460		<b>STYL ARM alu&amp;bl</b> STYL 4L-ARM-zz xx GB
									<b>STYL ARM chrome</b> STYL 4L-ARM-CR xx GB
	0.18	1	10		22.5	450	460		<b>STYL - 3 alu&amp;bl</b> STYL-3 B-zz xx GB
3	0.32	3		24	6.1	460	430		<b>SYLWIA S chrome</b> SYLWIA-S CF-CR xx GB
	0.36	2		16	6.4	460	430		<b>SYLWIA S ARM chrome</b> SYLWIA-S CFP-CR NF-xx xx GB
10	0.4	5	20		4.9	410	430		<b>VESTA NEW CFS alu</b> VESTA-NEW CFS-ALU xx GB
									<b>VESTA NEW CFS chrome</b> VESTA-NEW CFS-CR xx GB
10	0.4	5	20		4.9	410	430		<b>VESTA NEW CFP alu</b> VESTA-NEW CFP-ALU NF-PP xx GB
									<b>VESTA NEW CFP chrome</b> VESTA-NEW CFP-CR NF-PP xx GB
10	0.4	5	20		4.9	410	430		<b>VESTA NEW CFS click alu</b> VESTA-NEW-CLICK CFS-ALU xx GB
									<b>VESTA NEW CFS click chrome</b> VESTA-NEW-CLICK CFS-CR xx GB
10	0.4	5	20		4.9	410	430		<b>VESTA NEW CFP click alu</b> VESTA-NEW-CLICK CFP-ALU NF-PP xx GB
									<b>VESTA NEW CFP click chrome</b> VESTA-NEW-CLICK CFP-CR NF-PP xx GB
	0.4	4	16		5.8	405	415		<b>VESTA NEW WOOD CFS wood alu/bl</b> VESTA-WOOD CFS-ALU WOOD xx GB
									<b>VESTA NEW WOOD CFS wood chrome</b> VESTA-WOOD CFS-CR WOOD xx GB
	0.4	4	16		5.8	405	415		<b>VESTA NEW WOOD CFS laminate alu/bl</b> VESTA-WOOD CFS-ALU LAMINAT xx GB
									<b>VESTA NEW WOOD CFS laminate chrome</b> VESTA-WOOD CFS-CR LAMINAT xx GB

Price Group							
PLYWOOD	LAMINATE	GROUP 0 (M, V, C)	GROUP 1 (BN, YB, EF, SM, KN)	GROUP 2 (YN, CM, UNY, VL, XR, CSE)	GROUP 3 (OX, SP FRONT, RN)	GROUP 4 (LE FRONT, SD FRONT, LDS)	GROUP 5 (LE, SD)
		94	99	102			
		99	103	107			
		320	327	328			
		97	99	102			
		152	153	156			
		106	109				
		110	114				
		142	145				
		147	150				
		112	115				
		117	120				
		148	152				
		153	156				
145							
149							
	167						
	172						

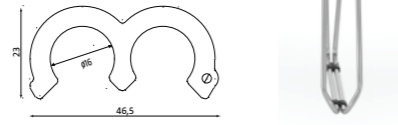

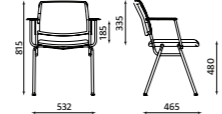
# CONFERENCE AND VISITOR CHAIRS

stacking max. no of pcs	card box diameter [m]	no. of pcs per card box	no. of pcs per EURO pallet	no. of pcs per 1200x1200 mm pallet	net weight [kg]	chair seat - width [mm]	chair seat - depth [mm]	MODEL [mm]	
0.4	4	4	16		6.5	405	415	 <b>VESTA NEW WOOD CFP wood alu/bl</b> VESTA-WOOD CFP NF-xx WOOD xx GB	
								 <b>VESTA NEW WOOD CFP wood chrome</b> VESTA-WOOD CFP-CR NF-xx WOOD xx GB	
0.4	4	4	16		6.5	405	415	 <b>VESTA NEW WOOD CFP laminate alu/bl</b> VESTA-WOOD CFP NF-xx LAMINAT xx GB	
								 <b>VESTA NEW WOOD CFP laminate chrome</b> VESTA-WOOD CFP-CR NF-xx LAMINAT xx GB	
Easy transportation after stacking - max 25 pcs.								 <b>VESTA NEW TROLLEY alu</b>	
								 <b>VESTA NEW WOOD click (nonretrofitable)</b>	
								 <b>VESTA NEW LINK (retrofit table) to connect back legs in two spots (2 pcs in a set)</b> LINK-PLASTIC 16	
10	0.4	4	pallet 1200x1200: 50	5	440	405		<b>V-SIT alu &amp; bl</b> V-SIT 4L-zz xx GB	
								<b>V-SIT chrome</b> V-SIT 4L-CR xx GB	
10	0.4	4	pallet 1200x1200: 50	5.8	440	405		<b>V-SIT ARM alu &amp; bl</b> V-SIT 4L-ARM-zz NF xx GB	
								<b>V-SIT ARM chrome</b> V-SIT 4L-ARM-CR NF xx GB	
<b>WAIT</b>									











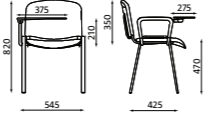

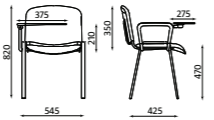

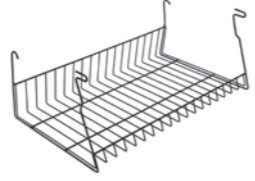
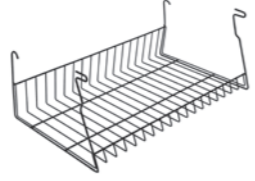
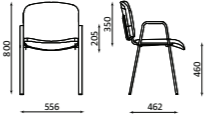

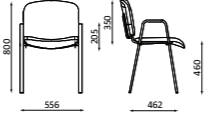
Price Group							
PLYWOOD	LAMINATE	GROUP 0 (M, V, C)	GROUP 1 (BN, YB, EF, SM, KN)	GROUP 2 (YN, CM, UNY, VL, XR, CSE)	GROUP 3 (OX, SP FRONT, RN)	GROUP 4 (LE FRONT, SD FRONT, LDS)	GROUP 5 (LE, SD)
181							
186							
	202						
	207						
				467			
				6			
				6			
		95	97	105	only in OX 114		
		105	107	116	only in OX 124		
		111	113	121	only in OX 130		
		121	122	132	only in OX 140		
Prices on page 70							

# CONFERENCE AND VISITOR CHAIRS

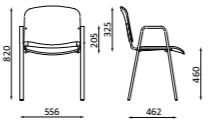
stacking max. no of pcs	card box diameter [mm]	no. of pcs per card box	no. of pcs per EURO pallet	no. of pcs per 1200×1200mm pallet	net weight [kg]	chair seat - width [mm]	chair seat - depth [mm]	MODEL [mm]	
10	0.4	4	pallet 1200×1200: 32		6.7	475	415	ISO alu&bl ISO 4L-zz xx GB	
								ISO chrome ISO 4L-CR xx GB	
10	0.4	4	pallet 1200×1200: 32		8.7	475	415	ISO ARM alu&bl ISO 4L-zz ARM xx GB	
								ISO ARM chrome ISO 4L-CR ARM xx GB	
10	0.4	4	pallet 1200×1200: 50		6.7	475	415	ISO BIANCO chrome ISO-BIANCO 4L-CR xx GB	
10	0.4	4	pallet 1200×1200: 32		6	475	415	ISO ERGO MESH alu&bl ISO-ERGO-MESH 4L-zz BA-xx SE-xx GB	
								ISO ERGO MESH chrome ISO-ERGO-MESH 4L-CR BA-xx SE-xx GB	
10	0.4	4	pallet 1200×1200: 32		5.8	475	415	ISO NET alu&bl ISO-NET 4L-zz BA-xx SE-xx GB	
								ISO NET chrome ISO-NET 4L-CR BA-xx SE-xx GB	
4	0.4	3	12		6.8	475	415	ISO NET cf alu&bl ISO-NET CF-zz BA-xx SE-xx GB	
								ISO NET cf chrome ISO-NET CF-CR BA-xx SE-xx GB	
4	0.4	4	12		6.3	470	468	ISO ERGO MESH cf alu&bl ISO-ERGO-MESH CF-zz BA-xx SE-xx GB	
								ISO CF ERGO MESH cf chrome ISO-ERGO-MESH CF-CR BA-xx SE-xx GB	
12	0.4	4 or 5	pallet 1200×1200: 32 or 40		5.4	460	405	ISO plastic alu&bl ISO-PLASTIK 4L-zz xx GB	
								ISO plastic chrome ISO-PLASTIK 4L-CR xx GB	
5	0.39	5	pallet 1200×1200: 8		5.4	460	405	ISO plastic cfs alu&bl ISO-PLASTIK CFS-zz xx GB	
								ISO plastic cfs chrome ISO-PLASTIK CFS-CR xx GB	

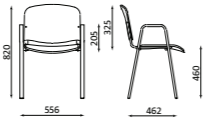

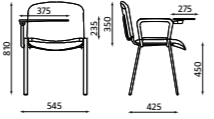
PLYWOOD	Price Group		
	GROUP 0 (M, V, C)	GROUP 1 (BN, YB, EF, SM, KN)	GROUP 2 (YN, CM, UNY, VL, XR, CSE)
	72	73	75
	76	78	79
	95	97	99
	100	102	103
	78	79	81
	91	82	99
	95	97	103
	108	114	119
	113	119	124
	127	130	135
	132	135	140
	103	107	113
	108	111	118
	PLASTIC 62		
	PLASTIC 67		
	PLASTIC 87		
	PLASTIC 103		

# CONFERENCE AND VISITOR CHAIRS

stacking max. no of pcs	card box diameter [mm]	no. of pcs per card box	no. of pcs per EURO pallet	no. of pcs per 1200 x 1000 mm pallet	net weight [kg]	chair seat - width [mm]	chair seat - depth [mm]	MODEL [mm]	
0.4	4	4	pallet 1200x1200: 32		9.5	475	415	 ISO TR alu & bl ISO 4L-zz xx TR GB	 ISO TR chrome ISO 4L-CR xx TR GB
								 ISO TR-xx alu & bl ISO 4L-zz xx TR-xx GB	 ISO TR-xx chrome ISO 4L-CR xx TR-xx GB
0.4	4	4	pallet 1200x1200: 32		8.5	475	415	 basket alu for ISO	 basket chrome for ISO
10	0.5	4	pallet 1200x1200: 24		6.9	475	415	 ISO W alu & bl ISO-W 4L-zz xx GB	 ISO W chrome ISO-W 4L-CR xx GB
								 ISO W extra alu & bl ISO-W 4L-zz NF-xx xx GB	 ISO W extra chrome ISO-W 4L-CR NF-xx xx GB
10	0.5	4	pallet 1200x1200: 24		5.7	475	415	 ISO wood alu & bl ISO 4L-zz WOOD-xx GB	 ISO wood chrome ISO 4L-CR WOOD-xx GB
								 ISO W wood alu & bl ISO-W 4L-zz WOOD-xx GB	 ISO W wood chrome ISO-W 4L-CR WOOD-xx GB
10	0.5	4	pallet 1200x1200: 24		5.7	475	415	 ISO W wood extra alu & bl ISO-W 4L-zz NF-xx WOOD-xx GB	 ISO W wood extra chrome ISO-W 4L-CR NF-xx WOOD-xx GB
								 ISO wood TR-xx alu & bl ISO 4L-zz WOOD-xx TR-xx GB	 ISO wood TR-xx chrome ISO 4L-CR WOOD-xx TR-xx GB

PLYWOOD	Price Group		
	GROUP 0 (M, V, C)	GROUP 1 (BN, YB, EF, SM, KN)	GROUP 2 (YN, CM, UNY, VL, XR, CSE)
	113	114	116
	116	118	119
	118	119	121
	122	124	126
	37		
	40		
	79	81	83
	86	87	89
	95	97	99
	102	103	105
103			
108			
120			
126			
136			
142			
157			
161			

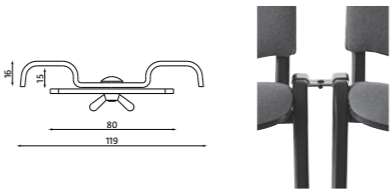
# CONFERENCE AND VISITOR CHAIRS

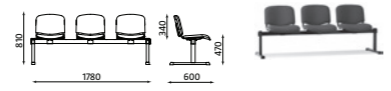
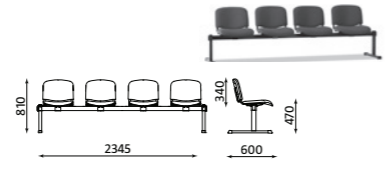
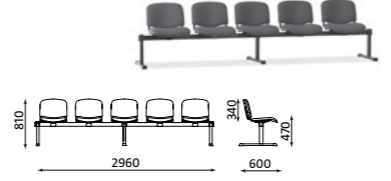
stacking max. no of pcs	card box diameter [mm]	no. of pcs per card box	no. of pcs per EURO pallet	no. of pcs per 1200x1000mm pallet	net weight [kg]	chair seat - width [mm]	chair seat - depth [mm]	MODEL [mm]	
									<b>ISO link alu&amp;bl</b> LINK-METAL 30x15  <b>ISO link chrome</b> LINK-METAL 30x15
0.15		1	10		19.4	475	415		<b>ISO-2 alu&amp;bl</b> ISO-2 B-zz xx GB
0.18		1	10		26.2	475	415		<b>ISO-3 alu&amp;bl</b> ISO-3 B-zz xx GB
0.21		1	8		32.9	475	415		<b>ISO-4 alu&amp;bl</b> ISO-4 B-zz xx GB
0.21		1	8		41.7	475	415		<b>ISO-5 alu&amp;bl</b> ISO-5 B-zz xx GB

PLYWOOD	Price Group		
	GROUP 0 (M, V, C)	GROUP 1 (BN, YB, EF, SM, KN)	GROUP 2 (YN, CM, UNY, VL, XR, CSE)
		3	
		5	
	224	227	231
	285	290	295
	351	357	365
	426	432	442

Wait



OPTIONS FOR WAIT

Additional equipment/information	Symbol	Extra charge
Transparent polycarbonate backrest	<b>PC</b>	22
Felt glides for hard surfaces	<b>GBF</b>	8

Apart from the product number/code, please specify option symbol, fabric and finish codes to complete an order.

Wait

WAIT CHAIRS

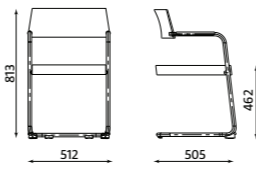
Model	Description	Versions	Price group				
			1	2	3	4	5
<b>WAIT CFP PP</b> 	Visitor chair, cantilever frame with armrests, alu painted. Armpads upholstered in black imitation leather, black PP backrest. Plastic glides for soft surfaces.		264	279	285	291	313
		CFP-CR Chromium Version	29				







PRICE GROUP 1: Bondai, Lucia, Sempre, Kaiman, Oban  
 PRICE GROUP 2: Contract, Microfibra, Nexus, Valencia, Xtreme

PRICE GROUP 3: King L Elast, Oxygen, Silvertex, Flex  
 PRICE GROUP 4: Blazer, Fame

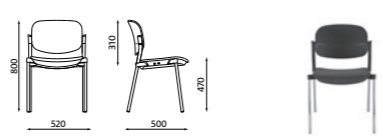
PRICE GROUP 5: Fine Leather LE, Fine Leather SD, Fine Leather Q

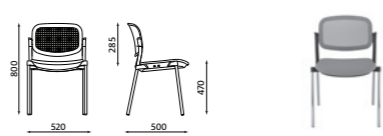
# STEP LINE – Chairs

for waiting and conference rooms

stacking max. no of pcs	card box diameter [m]	no. of pcs per card box	no. of pcs per EURO pallet	no. of pcs per 1200x1000 mm pallet	net weight [kg]	seat of chair – width [mm]	seat of chair – depth [mm]	MODEL [mm]	3 YEARS WARRANTY
5	0.46	4	16		5.9	460	480	 <b>STEP – 31 BL – FL BL – NA</b>  * STEP-31B-FLBL-NA-xx	
								 <b>STEP – 31 BL – FL ALU – NA</b>  * STEP-31B-FLALU-NA-xx	
								 <b>STEP – 31 BL – FL CR – NA</b>  * STEP-31B-FLCR-NA-xx	
5	0.46	4	16		5.9	460	480	 <b>STEP – 31 GR – FL BL – NA</b>  * STEP-31GR-FLBL-NA-xx	
								 <b>STEP – 31 GR – FL ALU – NA</b>  * STEP-31GR-FLALU-NA-xx	
								 <b>STEP – 31 GR – FL CR – NA</b>  * STEP-31GR-FLCR-NA-xx	
5	0.46	4	16		5.5	460	480	 <b>STEP – 32 BL – FL BL – NA</b>  * STEP-32BL-FLBL-NA-xx-xx	
								 <b>STEP – 32 BL – FL ALU – NA</b>  * STEP-32BL-FLALU-NA-xx-xx	
								 <b>STEP – 32 BL – FL CR – NA</b>  * STEP-32BL-FLCR-NA-xx-xx	
5	0.46	4	16		5.5	460	480	 <b>STEP – 32 GR – FL BL – NA</b>  * STEP-32GR-FLBL-NA-xx-xx	
								 <b>STEP – 32 GR – FL ALU – NA</b>  * STEP-32GR-FLALU-NA-xx-xx	
								 <b>STEP – 32 GR – FL CR – NA</b>  * STEP-32GR-FLCR-NA-xx-xx	
5	0.36	4	16		5.4	450	460	 <b>STEP – 33 BL – FL BL – NA</b>  * STEP-33BL-FLBL-NA	
								 <b>STEP – 33 BL – FL ALU – NA</b>  * STEP-33BL-FLALU-NA	
								 <b>STEP – 33 BL – FL CR – NA</b>  * STEP-33BL-FLCR-NA	
5	0.36	4	16		5.4	450	460	 <b>STEP – 33 GR – FL BL – NA</b>  * STEP-33GR-FLBL-NA	
								 <b>STEP – 33 GR – FL ALU – NA</b>  * STEP-33GR-FLALU-NA	
								 <b>STEP – 33 GR – FL CR – NA</b>  * STEP-33GR-FLCR-NA	

\*  The chairs are not to be sold in: France, Portugal, Hungary, Czech Republic.

## SEAT AND BACKREST

- 31 – upholstered seat and backrest
- 32 – upholstered seat and mesh backrest
- 33 – seat and backrest made of plastic
- BL (follow the digit) – plastic elements in black colour
- GR (follow the digit) – plastic elements in grey colour RAL 7045

Eg. 32GR – upholstered seat and mesh backrest, seat cover and backrest (as well as armrests, writing tablet, castors if present) in grey colour

## FRAME

- FL – four legs
- BL (follow the symbol FL) – frame in black colour
- ALU (follow the symbol FL) – frame in alu colour
- CR (follow the symbol FL) – chrome plated frame
- NA – version without armrests
- ARM – version with armrests (colour adequate with seat and backrest)
- RL – frame on castors (rolls) (colour adequate with seat and backrest)
- TR – writing tablet for right-handed (colour adequate with seat and backrest)
- TL – writing tablet for left-handed (colour adequate with seat and backrest)
- CLICK – chairs connector, comes with all versions apart from RL and benches



STEP – 31 BL – FL BL – ARM – TR

STEP – 31 GR – FL CR – RL GR – NA

SEAT AND backrest	frame	armrests	Price Group			
			GROUP 0 (M, V, C)	GROUP 1 (BN, YB, EF, SM, KN)	GROUP 2 (YN, CM, UNY, VL, XR)	GROUP 3 (OX)
upholstered [31] BLACK PP	four legs – black [FL BL]	without armrests [NA]	165	171	181	192
	four legs – alu [FL ALU]		165	171	181	192
	four legs – chrome [FL CR]		173	179	189	200
upholstered [31] GREY PP	four legs – black [FL BL]		176	181	190	201
	four legs – alu [FL ALU]		176	181	190	201
	four legs – chrome [FL CR]		184	189	198	209
mesh [32] BLACK PP	four legs – black [FL BL]		174	178	182	190
	four legs – alu [FL ALU]		174	178	182	190
	four legs – chrome [FL CR]		182	186	190	198
mesh [32] GREY PP	four legs – black [FL BL]		181	184	189	197
	four legs – alu [FL ALU]		181	184	189	197
	four legs – chrome [FL CR]		189	192	197	205
plastic [33] BLACK PP	four legs – black [FL BL]	148				
	four legs – alu [FL ALU]	148				
	four legs – chrome [FL CR]	156				
plastic [33] GREY PP	four legs – black [FL BL]	158				
	four legs – alu [FL ALU]	158				
	four legs – chrome [FL CR]	166				

prices of extra elements		
frame with castors [RL]	black or alu	+41
armrest	black	+22
	grey	+32
writing tablet RIGHT	black	+65
	grey	+91
writing tablet LEFT	black	+73
	grey	+99
CART		210
CLICK		11



**CART**  
(enables stacking and transporting up to 10 pcs.)

# STEP LINE – Benches-3

for waiting and conference rooms

card box diameter [m <sup>2</sup> ]	no. of pcs per card box	no. of pcs per EURO pallet	no. of pcs per 1200x1000mm pallet	net weight [kg]	seat of chair - width [mm]	seat of chair - depth [mm]	MODEL [mm]	3 YEARS WARRANTY
0.22	8	8	23	460	480		STEP - 331 BL - FR BL STEP-331BL-FRBL-xx	!
							STEP - 331 BL - FR GR STEP-331BL-FRGR-xx	!
							STEP - 331 BL - FR CR STEP-331BL-FRCR-xx	!
0.22	8	8	23	460	480		STEP - 331 GR - FR BL STEP-331GR-FRBL-xx	!
							STEP - 331 GR - FR GR STEP-331GR-FRGR-xx	!
							STEP - 331 GR - FR CR STEP-331GR-FRCR-xx	!
0.22	8	8	23	460	480		STEP - 332 BL - FR BL STEP-332BL-FRBL-xx-xx	!
							STEP - 332 BL - FR GR STEP-332BL-FRGR-xx-xx	!
							STEP - 332 BL - FR CR STEP-332BL-FRCR-xx-xx	!
0.22	8	8	23	460	480		STEP - 332 GR - FR BL STEP-332GR-FRBL-xx-xx	!
							STEP - 332 GR - FR GR STEP-332GR-FRGR-xx-xx	!
							STEP - 332 GR - FR CR STEP-332GR-FRCR-xx-xx	!
0.22	8	8	23	450	460		STEP - 333 BL - FR BL STEP-333BL-FRBL	!
							STEP - 333 BL - FR GR STEP-333BL-FRGR	!
							STEP - 333 BL - FR CR STEP-333BL-FRCR	!
0.22	8	8	23	450	460		STEP - 333 GR - FR BL STEP-333GR-FRBL	!
							STEP - 333 GR - FR GR STEP-333GR-FRGR	!
							STEP - 333 GR - FR CR STEP-333GR-FRCR	!



Table top for benches

\* ! The chairs are not to be sold in: France, Portugal, Hungary, Czech Republic.

333, 433 - first digit stands for number of places, two remaining type of seat and backrest  
 431 - upholstered seat and backrest, four places  
 432 - upholstered seat and mesh backrest, four places  
 433 - seat and backrest made of plastic, four places  
 BL (follow the digit) - black - plastic elements in black colour  
 GR (follow the digit) - grey - plastic elements in grey colour RAL 7045  
 Eg. 432GR - upholstered seat and mesh backrest, seat cover and backrest frame in grey colour, four places

FR - frame  
 BL (follow the symbol FR) - bench's legs in black colour  
 GR (follow the symbol FR) - bench's legs in grey colour RAL 7045  
 CR (follow the symbol FR) - bench's legs chrome plated  
 T - stands for table top instead of one seat

backrest	frame	SEAT	Price Group			
			GROUP 0 (M, V, C)	GROUP 1 (BN, YB, EF, SM, KN)	GROUP 2 (YN, CM, UNY, VL, XR)	GROUP 3 (OX)
upholstered [331] BLACK PP	bench's legs black [FR BL]	5	680	696	724	759
	bench's legs grey [FR GR]		680	696	724	759
	bench's legs chrome [FR CR]		713	727	756	791
upholstered [331] GREY PP	bench's legs black [FR BL]		680	696	724	759
	bench's legs grey [FR GR]		680	696	724	759
	bench's legs chrome [FR CR]		742	727	756	791
mesh [332] BLACK PP	bench's legs black [FR BL]		734	743	759	783
	bench's legs grey [FR GR]		734	743	759	783
	bench's legs chrome [FR CR]		767	777	793	816
mesh [332] GREY PP	bench's legs black [FR BL]		754	764	778	804
	bench's legs grey [FR GR]		754	764	778	804
	bench's legs chrome [FR CR]		786	796	810	836
plastic [333] BLACK PP	bench's legs black [FR BL]	648				
	bench's legs grey [FR GR]	648				
	bench's legs chrome [FR CR]	680				
plastic [333] GREY PP	bench's legs black [FR BL]	677				
	bench's legs grey [FR GR]	677				
	bench's legs chrome [FR CR]	708				

# STEP LINE - Benches-4

for waiting and conference rooms

card box diameter [mm]	no. of pcs per card box	no. of pcs per EURO pallet	no. of pcs per 1200x1000mm pallet	net weight [kg]	seat of chair - width [mm]	seat of chair - depth [mm]	MODEL [mm]	3 YEARS WARRANTY
0.22	8	8	30	460	480		STEP - 431 BL - FR BL STEP-431BL-FRBL-xx	!
							STEP - 431 BL - FR GR STEP-431BL-FRGR-xx	!
							STEP - 431 BL - FR CR STEP-431BL-FRCR-xx	!
0.22	8	8	30	460	480		STEP - 431 GR - FR BL STEP-431GR-FRBL-xx	!
							STEP - 431 GR - FR GR STEP-431GR-FRGR-xx	!
							STEP - 431 GR - FR CR STEP-431GR-FRCR-xx	!
0.22	8	8	30	460	480		STEP - 432 BL - FR BL STEP-432BL-FRBL-xx-xx	!
							STEP - 432 BL - FR GR STEP-432BL-FRGR-xx-xx	!
							STEP - 432 BL - FR CR STEP-432BL-FRCR-xx-xx	!
0.22	8	8	30	460	480		STEP - 432 GR - FR BL STEP-432GR-FRBL-xx-xx	!
							STEP - 432 GR - FR GR STEP-432GR-FRGR-xx-xx	!
							STEP - 432 GR - FR CR STEP-432GR-FRCR-xx-xx	!
0.22	8	8	30	460	480		STEP - 433 BL - FR BL STEP-433BL-FRBL	!
							STEP - 433 BL - FR GR STEP-433BL-FRGR	!
							STEP - 433 BL - FR CR STEP-433BL-FRCR	!
0.22	8	8	30	460	480		STEP - 433 GR - FR BL STEP-433GR-FRBL	!
							STEP - 433 GR - FR GR STEP-433GR-FRGR	!
							STEP - 433 GR - FR CR STEP-433GR-FRCR	!



Table top for benches

\* ! The chairs are not to be sold in: France, Portugal, Hungary, Czech Republic.

333, 433 - first digit stands for number of places, two remaining type of seat and backrest  
 431 - upholstered seat and backrest, four places  
 432 - upholstered seat and mesh backrest, four places  
 433 - seat and backrest made of plastic, four places  
 BL (follow the digit) - black - plastic elements in black colour  
 GR (follow the digit) - grey - plastic elements in grey colour RAL 7045  
 Eg. 432GR - upholstered seat and mesh backrest, seat cover and backrest frame in grey colour, four places





FR - frame  
 BL (follow the symbol FR) - bench's legs in black colour  
 GR (follow the symbol FR) - bench's legs in grey colour RAL 7045  
 CR (follow the symbol FR) - bench's legs chrome plated  
 T - stands for table top instead of one seat

			Price Group			
backrest	frame	SEAT	GROUP 0 (M, V, C)	GROUP 1 (BN, YB, EF, SM, KN)	GROUP 2 (YN, CM, UNY, VL, XR)	GROUP 3 (OX)
upholstered [431] BLACK PP	bench's legs black [FR BL]	6	818	837	877	923
	bench's legs grey [FR GR]		818	837	877	923
	bench's legs chrome [FR CR]		850	869	893	955
upholstered [431] GREY PP	bench's legs black [FR BL]		826	845	885	931
	bench's legs grey [FR GR]		826	845	885	931
	bench's legs chrome [FR CR]		858	877	917	963
mesh [432] BLACK PP	bench's legs black [FR BL]	875	888	907	940	
	bench's legs grey [FR GR]	875	888	907	940	
	bench's legs chrome [FR CR]	907	920	939	972	
mesh [432] GREY PP	bench's legs black [FR BL]	901	915	934	968	
	bench's legs grey [FR GR]	901	915	934	968	
	bench's legs chrome [FR CR]	933	947	966	999	
plastic [433] BLACK PP	bench's legs black [FR BL]	797				
	bench's legs grey [FR GR]	797				
	bench's legs chrome [FR CR]	829				
plastic [433] GREY PP	bench's legs black [FR BL]	837				
	bench's legs grey [FR GR]	837				
	bench's legs chrome [FR CR]	869				

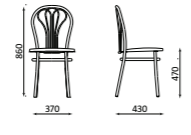

stacking max. no of pcs	card box diameter [m]	no. of pcs per card box	no. of pcs per EURO pallet	no. of pcs per 1200x1000mm pallet	net weight [kg]	chair seat - width [mm]	chair seat - depth [mm]	MODEL [mm]	
8	0.25	6	100	60	4.4	400	430	<b>ASCONA</b> ASCONA 4L-CR xx GB	
8	0.25	6	30	48	4	400	430	<b>CORTINA</b> CORTINA 4L-CR xx GB	
4	0.32	2	pallet 1200x1200: 16		3.5	410	420	<b>EL SOL aluminum</b> EL-SOL 4L-aluminum xx GB	
4	0.46	3	12		5.4	530	430	<b>FANO alu&amp;bl</b> FANO 4L-zz MAT.xx GB <b>FANO cr&amp;RAL</b> FANO 4L-zz MAT.xx GB	
	0.45	3	12		5.8	530	430	<b>FANO 4L-ALU/BL seat-plus</b> FANO 4L-xx SEAT-PLUS xx GB <b>FANO 4L-CR/RAL seat-plus</b> FANO 4L-xx SEAT-PLUS xx GB	
<b>FONDO</b>									
	0.32	2	16		4.2	425	425	<b>NERON alu&amp;bl</b> NERON 4L-zz xx GB <b>NERON cr&amp;RAL</b> NERON 4L-zz xx GB	
	0.25	2	16		4.5	ø 410		<b>TIZIANO alu&amp;bl</b> TIZIANO 4L-zz xx GB <b>TIZIANO cr&amp;RAL</b> TIZIANO 4L-zz xx GB	
	0.26	2	16		5.1	ø 410		<b>TULIPAN alu&amp;bl</b> TULIPAN 4L-zz xx GB <b>TULIPAN cr&amp;RAL</b> TULIPAN 4L-zz xx GB	
	0.25	2	16		5.3	ø 410		<b>TULIPAN PLUS alu&amp;bl</b> TULIPAN 4L-zz PLUS-xx GB <b>TULIPAN PLUS cr&amp;RAL</b> TULIPAN 4L-zz PLUS-xx GB	
	0.22	2	16		5	ø 400		<b>TULIPAN wood alu&amp;bl</b> TULIPAN 4L-zz WOOD18-xx GB <b>TULIPAN wood cr&amp;RAL</b> TULIPAN 4L-zz WOOD18-xx GB	

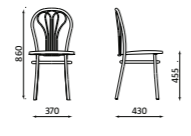
PLYWOOD	Price Group					
	GROUP 0 (M, V, C)	GROUP 1 (BN, YB, EF, SM, KN)	GROUP 2 (YN, CM, UNY, VL, XR, CSE)	GROUP 3 (OX)	GROUP 4 (LE FRONT, SD FRONT, LDS)	GROUP 5 (LE, SD)
			PLASTIC 60			
			PLASTIC 52			
			PLASTIC 175			
			PLASTIC 158			
			PLASTIC 165			
	175	181	189	197	only in LDS 205	
	181	188	196	203	only in LDS 211	
Prices on page 84						
	95	97	100			
	101	103	106			
	96	98	99			
	103	104	106			
	77	79	80			
	83	85	86			
	98	99	101			
	104	106	107			
86						
92						

stacking max. no of pcs	card box diameter [m]	no. of pcs per card box	no. of pcs per EURO pallet	no. of pcs per 1200x1000mm pallet	net weight [kg]	chair seat - width [mm]	chair seat - depth [mm]	MODEL [mm]	3 YEARS WARRANTY
								<b>TULIPAN HOCKER</b>	
								<b>TULIPAN 7/8</b>	
0.26		2	16		4.4	Ø400		<b>VENUS alu&amp;bl</b> VENUS 4L-zz xx GB	
								<b>VENUS cr&amp;RAL</b> VENUS 4L-zz xx GB	
0.26		2	16		4.6	Ø400		<b>VENUS wood alu&amp;bl</b> VENUS 4L-zz WOOD18-xx GB	
								<b>VENUS wood cr&amp;RAL</b> VENUS 4L-zz WOOD18-xx GB	
								<b>VENUS HOCKER</b>	
								<b>VENUS 7/8</b>	

Price Group						
PLYWOOD	GROUP 0 (M, V, C)	GROUP 1 (BN, YB, EF, SM, KN)	GROUP 2 (YN, CM, UNY, VL, XR, CSE)	GROUP 3 (OX)	GROUP 4 (LE FRONT, SD FRONT, LDS)	GROUP 5 (LE, SD)
Prices on pages 86						
Prices on pages 86						
	80	82	83			
	86	88	90			
94						
101						
Prices on pages 88						
Prices on pages 88						

# Cafe LGW



## OPTIONS FOR CAFE LGW















Additional equipment/ information	Symbol	Extra charge			
		Group 0	Group 1	Group 2	Others
Seat with upholstered cushion, wooden backrest	<b>SEAT PLUS</b>	13	16	19	
Seat and backrest with upholstered cushion	<b>PLUS</b>	24	30	37	
Fully upholstered seat and backrest	<b>A PLUS</b>	29	33	40	
Front part of the chair fully upholstered	<b>B PLUS</b>	40	45	51	
Wood stain with slightly visible wood grain on backrest and seat					13
Wood stain with slightly visible wood grain on frame					11
Laminate on seat and backrest, frame 1.007	<b>LAMINATE</b>				22
Glides for hard floors	<b>GBF</b>				8

## CAFE LGW CHAIRS

Model	Price
	Plywood
<b>ALANI LGW</b> 	288
<b>AMMI LGW</b> 	288
<b>CAFE-II LGW</b> 	269
<b>CAFE-IV LGW</b> 	269
<b>CAFE-VI LGW</b> 	269

## CAFE LGW CHAIRS

Model	Price
	Plywood
<b>CAFE-VII LGW</b> 	269
<b>CAFE-IX LGW</b> 	269
<b>CAFE-XII LGW</b> 	288
<b>LAKKA LGW</b> 	288
<b>LANTANA LGW</b> 	288
<b>VERBENA LGW</b> 	288
<b>CAFE-VII A PLUS LGW</b> 	see options for Cafe A PLUS LGW chair on page 82
<b>CAFE-VII B PLUS LGW</b> 	see options for Cafe A PLUS LGW chair on page 82

stacking max. no of pcs	card box diameter [m]	no. of pcs per card box	no. of pcs per EURO pallet	no. of pcs per 1200 x 1000 mm pallet	net weight [kg]	seat of chair - width [mm]	seat of chair - depth [mm]	MODEL [mm]			
											
6	0.35	4		32	4.6	445	410				<b>FONDO PP alu&amp;bl</b> FONDO-PP 4L-zz GLOSS.xx GB <b>FONDO PP cr&amp;RAL</b> FONDO-PP 4L-zz GLOSS.xx GB
3	0.4	4		32	5.4	445	410				<b>FONDO PP arm alu&amp;bl</b> FONDO-PP 4L-ARM-zz GLOSS.xx GB <b>FONDO PP arm cr&amp;RAL</b> FONDO-PP 4L-ARM-zz GLOSS.xx GB
4	0.41	4		16	6.4	445	400				<b>FONDO PP CFS-ROD CR</b>
6	0.49	4	12		9	445	410				<b>FONDO HOCKER alu&amp;bl</b> FONDO HOCKER-zz GLOSS.xx GB <b>FONDO HOCKER cr&amp;RAL</b> FONDO HOCKER-zz GLOSS.xx GB

Price	
	PLYWOOD
	PLASTIC 124
	PLASTIC 128
	PLASTIC 134
	PLASTIC 143
	PLASTIC 168
	PLASTIC 138
	PLASTIC 147

EXTRA CHARGE FOR FONDO						
DESCRIPTION	VERSIONS	GROUP 0 (M, V, C)	GROUP 1 (BN, YB, EF, SM, KN)	GROUP 2 (YN, CM, UNY, VL, XR, CSE)	GROUP 3 (OX)	GROUP 4 (LDS)
Seat with upholstered cushion, plastic backrest	SEAT PLUS	13	16	19	24	30
Black glides with felt for hard surfaces (available with frames: 4L, 4L-ARM and Hocker)	GBF			3		
Transparent glides (PC) with felt (available with FONDO CFS-ROD)	GTF			3		
FONDO stacking cushion (for SEAT PLUS version only)				32		

Apart from the product number/code, please specify option symbol, fabric and finish codes to complete an order.











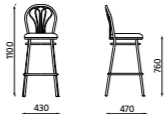







stacking max. no of pcs	card box diameter [m <sup>2</sup> ]	no. of pcs per card box	no. of pcs per EURO pallet	no. of pcs per 1200x1000mm pallet	net weight [kg]	chair seat - width [mm]	chair seat - depth [mm]	MODEL [mm]	
								CAFE VII hocker	
								CAFE VII Up&Down A-PLUS	
0.42		1		8	9.6	410	383	  	<b>EVORA 100 alu*</b> EVORA 100 X xx
									<b>EVORA 100 chrome*</b> EVORA 100 Z xx
0.42		1		8	9.6	430	379	  	<b>EVORA 101 alu*</b> EVORA 101 X xx
									<b>EVORA 101 chrome*</b> EVORA 101 Z xx
								FONDO HOCKER	
0.15		1	15		6.8		Ø 360	 	<b>RETRO chrome</b> RETRO-B HOCKER-CR xx GB
0.15		1	15		6.8		Ø 360	 	<b>RETRO TWIST chrome</b> RETRO-B-TWIST HOCKER-CR xx GB
0.23		1	8		6.3		Ø 410	  	<b>TULIPAN HOCKER alu&amp;bl</b> TULIPAN HOCKER-zz xx GB
									<b>TULIPAN HOCKER cr&amp;RAL</b> TULIPAN HOCKER-zz xx GB
0.3		2	16		6		Ø 410	  	<b>TULIPAN 7/8 alu&amp;bl</b> TULIPAN 7/8-zz xx GB
									<b>TULIPAN 7/8 cr&amp;RAL</b> TULIPAN 7/8-zz xx GB
0.23		1	8		6.3		Ø 400	  	<b>TULIPAN HOCKER wood alu&amp;bl</b> TULIPAN HOCKER-zz WOOD18-xx GB
									<b>TULIPAN HOCKER wood cr&amp;RAL</b> TULIPAN HOCKER-zz WOOD18-xx GB
0.3		2	16		6		Ø 400	  	<b>TULIPAN 7/8 wood alu&amp;bl</b> TULIPAN 7/8-zz WOOD18-xx GB
									<b>TULIPAN 7/8 wood cr&amp;RAL</b> TULIPAN 7/8-zz WOOD18-xx GB

\*Products of BNOS brand available to selected dealers and with extended warranty.



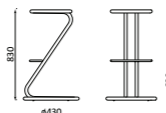
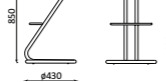

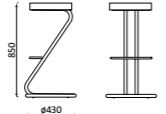
Price Group						
PLYWOOD	GROUP 0 (M, V, C)	GROUP 1 (BN, YB, EF, SM, SE, KN)	GROUP 2 (YN, CM, UNY, VL, XR, CSE)	GROUP 3 (OX)	GROUP 4 (LE FRONT, SD FRONT, LDS)	GROUP 5 (LE, SD)
Prices on page 96						
Prices on page 96						
281 VENEER 314						
316 VENEER 349						
		only in EF, SM, KN, YB 290	only in YN, UNY, VL, XR 306			403
		only in EF, SM, KN, YB 325	only in YN, UNY, VL, XR 341			438
Prices on page 84						
	126	129	132			
	145	148	151			
	126	128	131			
	137	139	142			
	100	102	103			
	110	111	113			
145						
156						
114						
124						

# CAFE CHAIRS



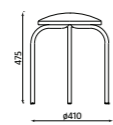

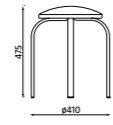











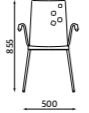

bar stools

stacking max. no of pcs	card box diameter [m]	no. of pcs per card box	no. of pcs per EURO pallet	no. of pcs per 1200x1000mm pallet	net weight [kg]	chair seat - width [mm]	chair seat - depth [mm]	MODEL [mm]	
0.23	1	8	6.3	Ø410				<b>VENUS HOCKER alu&amp;bl</b> VENUS HOCKER-zz xx GB	
								<b>VENUS HOCKER cr&amp;RAL</b> VENUS HOCKER-zz xx GB	
0.31	2	16	5.8	Ø410				<b>VENUS 7/8 alu&amp;bl</b> VENUS 7/8-zz xx GB	
								<b>VENUS 7/8 cr&amp;RAL</b> VENUS 7/8-zz xx GB	
0.23	1	8	6.3	Ø400				<b>VENUS HOCKER wood alu&amp;bl</b> VENUS HOCKER-zz WOOD18-xx GB	
								<b>VENUS HOCKER wood cr&amp;RAL</b> VENUS HOCKER-zz WOOD18-xx GB	
0.31	2	16	5.8	Ø400				<b>VENUS 7/8 wood alu&amp;bl</b> VENUS 7/8-zz WOOD18-xx GB	
								<b>VENUS 7/8 wood cr&amp;RAL</b> VENUS 7/8-zz WOOD18-xx GB	
0.39	1	4	8	400	425			<b>ZAFIRO HOCKER alu</b> ZAFIRO HOCKER-zz LAMINAT-XX GB	
								<b>ZAFIRO HOCKER chrome</b> ZAFIRO HOCKER-CR LAMINAT-XX GB	
0.24	2	20	7.3	Ø340				<b>ZETA 425 chrome</b> ZETA-425 HOCKER-CR xx GB	
0.15	2	28	6.5	Ø340				<b>ZETA chrome</b> ZETA HOCKER-CR xx GBz	

PLYWOOD	Price Group					
	GROUP 0 (M, V, C)	GROUP 1 (BN, YB, EF, SM, SE, KN)	GROUP 2 (YN, CM, UNY, VL, XR, CSE)	GROUP 3 (OX)	GROUP 4 (LE FRONT, SD FRONT, LDS)	GROUP 5 (LE, SD)
	128	129	131			
	139	141	142			
	105	106	108			
	114	116	117			
148						
160						
119						
129						
laminated only 290						
laminated only 326						
	125	137	128			
	110	112	114			

stacking max. no of pcs	card box diameter [m <sup>3</sup> ]	no. of pcs per card box	no. of pcs per EURO pallet	no. of pcs per 1200 x 1000 mm pallet	net weight [kg]	chair seat - width [mm]	chair seat - depth [mm]	MODEL [mm]	
6	0.10	4	60		2.9	Ø 340	475	  <p><b>CHICO alu&amp;bl</b> CHICO 4L-zz xx GB</p> <p><b>CHICO cr&amp;RAL</b> CHICO 4L-zz x GB</p>	
6	0.10	4	60		2.9	Ø 340	475	  <p><b>ZEPPO alu&amp;bl</b> ZEPPO 4L-zz xx GB</p> <p><b>ZEPPO cr&amp;RAL</b> ZEPPO 4L-zz xx GB</p>	

PLYWOOD	Price Group					
	GROUP 0 (M, V, C)	GROUP 1 (BN, YB, EF, SM, KN)	GROUP 2 (YN, CM, UNY, VL, XR)	GROUP 3 (OX)	GROUP 4 (LE FRONT, SD FRONT)	GROUP 5 (LE, SD)
	31					
	36					
	33					
	37					









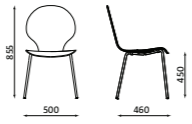

stacking max. no of pcs	card box diameter [m]	no. of pcs per card box	no. of pcs per EURO pallet	no. of pcs per 1200x1000mm pallet	net weight [kg]	seat of chair - width [mm]	seat of chair - depth [mm]	MODEL [mm]			
											
4	0.32	4		32	4.9	470	430				<b>ALANI alu&amp;bl</b> ALANI 4L-zz xx GB
4	0.34	4		32	4.8	395	425				<b>AMMI alu&amp;bl</b> AMMI 4L-zz xx GB
4	0.38	4		32	6.2	395	425				<b>AMMI arm alu&amp;bl</b> AMMI 4L-ARM-zz xx GB
4	0.32	4		32	4.8	430	430				<b>CAFE II alu&amp;bl</b> CAFE-II 4L-zz xx GB
4	0.32	4		32	4.9	470	430				<b>CAFE IV alu&amp;bl</b> CAFE-IV 4L-zz xx GB

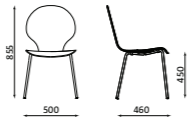
Price	
PLYWOOD	
	150
	152
	189
	126
	126

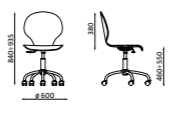
OPTIONS FOR PLYWOOD CAFE CHAIRS				
DESCRIPTION	VERSIONS	GROUP 0 (M, V, C)	GROUP 1 (BN, YB, EF, SM, KN)	GROUP 2 (YN, CM, UNY, VL, XR, CSE)
Seat with upholstered cushion, wooden backrest	SEAT PLUS	13	16	19
Cafe stacking cushion			25	
4-leg frame	CR&RAL (pg. 141)		6	
4-leg frame with armrests			10	
Wood stain with slightly visible wood grain on backrest and seat			13	
Laminated wood components with natural edge, protected with wax	LAMINATE		22	
Black glides with felt for hard surfaces (available with frames: 4L, 4L-ARM, CFS, Hocker, SQ)	GBF		3	
White glides (available with frames: 4L, 4L-ARM)	GW		3	

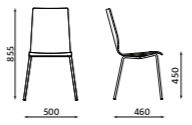
Apart from the product number/code, please specify option symbol, fabric and finish codes to complete an order.

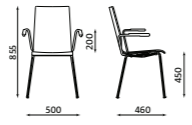



stacking max. no of pcs	card box diameter [m]	no. of pcs per card box	no. of pcs per EURO pallet	no. of pcs per 1200 x 1000 mm pallet	net weight [kg]	seat of chair - width [mm]	seat of chair - depth [mm]	MODEL [mm]		
										
4	0.32	4		32	5	470	430			<b>CAFE VI alu&amp;bl</b> CAFE-VI 4L-zz xx GB
	0.12	1	12	12	6.3	470	430			<b>CAFE VI gts</b> CAFE-VI ST20-CR GTS PST45-ALU xx SH
4	0.32 0.18*	4		32 64*	4.8	395	425			<b>CAFE VII alu&amp;bl</b> CAFE-VII 4L-zz xx GB
4	0.45	4		32	6.2	395	425			<b>CAFE VII arm alu</b> CAFE VII 4L-ARM/FRONT-zz NF-xx xx GB

OPTIONS FOR PLYWOOD CAFE CHAIRS				
DESCRIPTION	VERSIONS	GROUP 0 (M, V, C)	GROUP 1 (BN, YB, EF, SM, KN)	GROUP 2 (YN, CM, UNY, VL, XR, CSE)
Seat with upholstered cushion, wooden backrest	SEAT PLUS	13	16	19
Cafe stacking cushion			25	
4-leg frame	CR&RAL (pg. 141)		6	
4-leg frame with armrests		10		
Wood stain with slightly visible wood grain on backrest and seat			13	
Laminated wood components with natural edge, protected with wax	LAMINATE		22	
Black glides with felt for hard surfaces (available with frames: 4L, 4L-ARM, CFS, Hocker, SQ)	GBF		3	
White glides (available with frames: 4L, 4L-ARM)	GW		3	

Price	
PLYWOOD	
	126
	201
	126
	171

OPTIONS FOR PLYWOOD CAFE CHAIRS				
DESCRIPTION	VERSIONS	GROUP 0 (M, V, C)	GROUP 1 (BN, YB, EF, SM, KN)	GROUP 2 (YN, CM, UNY, VL, XR, CSE)
Seat with upholstered cushion, wooden backrest	SEAT PLUS	13	16	19
Seat and back with upholstered cushions	PLUS	24	30	37
Fully upholstered seat and backrest (only Cafe VII)	A PLUS	29	33	40
Front part of the chair fully upholstered (only Cafe VII)	B PLUS	40	45	51
Cafe stacking cushion			25	
4-leg frame	CR&RAL (pg. 141)		6	
4-leg frame with armrests		10		
Wood stain with slightly visible wood grain on backrest and seat			13	
Laminated armrest pads (refers to 4L-ARM A-PLUS version)	NF-LAMINATE		8	
Laminated wood components with natural edge, protected with wax	LAMINATE		22	
Black glides with felt for hard surfaces (available with frames: 4L, 4L-ARM, CFS, Hocker, SQ)	GBF		3	
White glides (available with frames: 4L, 4L-ARM)	GW		3	

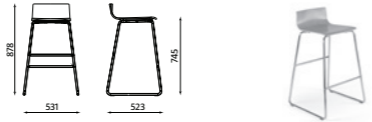
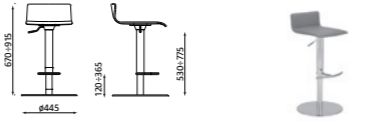
Apart from the product number/code, please specify option symbol, fabric and finish codes to complete an order

stacking max. no of pcs	card box diameter [m]	no. of pcs per card box	no. of pcs per EURO pallet	no. of pcs per 1200 x 1000mm pallet	net weight [kg]	seat of chair - width [mm]	seat of chair - depth [mm]	MODEL [mm]	
0.07	1	22		5.1	370	400		<b>CAFE VII Hocker</b> CAFE VII HOCKER-zz xx GB	
0.25	1	8	14.9	355	390		<b>CAFE VII Up&amp;Down</b> CAFE VII UP&DOWN HOCKER-CR xx GBF (IT)		
0.19	1	10	6.9	395	460		<b>CAFE VII gts steel 23 chrome</b> CAFE-VII ST23-POL GTS PST45-ALU xx ESH		

Price
PLYWOOD
162
485
244

OPTIONS FOR PLYWOOD CAFE CHAIRS				
DESCRIPTION	VERSIONS	GROUP 0 (M, V, C)	GROUP 1 (BN, YB, EF, SM, KN)	GROUP 2 (YN, CM, UNY, VL, XR, CSE)
Seat with upholstered cushion, wooden backrest	SEAT PLUS	13	16	19
Seat and back with upholstered cushions	PLUS	24	30	37
Fully upholstered seat and backrest (only Cafe VII)	A PLUS	29	33	40
Front part of the chair fully upholstered (only Cafe VII)	B PLUS	40	45	51
Cafe stacking cushion			25	
4-leg frame	CR&RAL		6	
4-leg frame with armrests	(pg. 141)		10	
Wood stain with slightly visible wood grain on backrest and seat			13	
Laminated armrest pads (refers to 4L-ARM A-PLUS version)	NF-LAMINATE		8	
Laminated wood components with natural edge, protected with wax	LAMINATE		22	
Black glides with felt for hard surfaces (available with frames: 4L, 4L-ARM, CFS, Hocker, SQ)	GBF		3	
White glides (available with frames: 4L, 4L-ARM)	GW		3	

\*When packed disassembled, chair seat and frame separately.

Apart from the product number/code, please specify option symbol, fabric and finish codes to complete an order

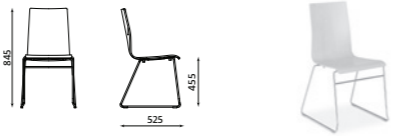

stacking max. no of pcs	card box diameter [m]	no. of pcs per card box	no. of pcs per EURO pallet	no. of pcs per 1200x1000mm pallet	net weight [kg]	seat of chair - width [mm]	seat of chair - depth [mm]	MODEL [mm]	3 YEARS WARRANTY
4	0.47	4	16		6	395	425		<b>CAFE VII cfs ROD bl</b> CAFE-VII CFS-ROD-BL WOOD-xx GT

Price
PLYWOOD
200

OPTIONS FOR CAFE VII CFS-ROD CHAIRS				
DESCRIPTION	VERSIONS	GROUP 0 (M, V, C)	GROUP 1 (BN, YB, EF, SM, KN)	GROUP 2 (YN, CM, UNY, VL, XR, CSE)
Seat with upholstered cushion, wooden backrest	SEAT PLUS*	19	22	25
Seat and back with upholstered cushions	PLUS*	32	37	43
Fully upholstered seat and backrest	A PLUS*	35	40	46
Front part of the chair fully upholstered	B PLUS*	46	51	57
Wood stain with slightly visible wood grain on backrest and seat			13	
Laminated wood components with natural edge, protected with wax	LAMINATE		22	
CFS-ROD	CR		8	
Transparent glides (PC) with felt	GTF		3	
Glides with interchangeable caps for soft surfaces (PP)	G2B		8	
Glides with interchangeable caps for hard surfaces (PP)	G2BF		11	
Glides linking into rows with interchangeable caps for soft surfaces (PP)	G2BL		11	
Glides linking into rows with interchangeable caps for hard surfaces (PP)	G2BLF		14	

\*Stacking cushion as a standard

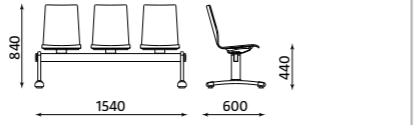
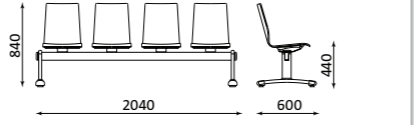
Apart from the product number/code, please specify option symbol, fabric and finish codes to complete an order.





stacking max. no of pcs	card box diameter [m]	no. of pcs per card box	no. of pcs per EURO pallet	no. of pcs per 1200×1000mm pallet	net weight [kg]	seat of chair - width [mm]	seat of chair - depth [mm]	MODEL [mm]	
									
	0.2	1	pallet 1200×1200: 8		24	395	425	<b>CAFE VII-3 chrome</b> CAFE VII-3 C-CR-xx xx GB	
	0.2	1	pallet 1200×1200: 8		27	395	425	<b>CAFE VII-4 chrome</b> CAFE VII-4 C-CR-xx xx GB	

Price	
PLYWOOD	
	617
	731

OPTIONS FOR PLYWOOD CAFE CHAIRS				
DESCRIPTION	VERSIONS	GROUP 0 (M, V, C)	GROUP 1 (BN, YB, EF, SM, KN)	GROUP 2 (YN, CM, UNY, VL, XR, CSE)
Wood stain with slightly visible wood grain on backrest and seat			13	
Laminated wood components with natural edge, protected with wax	LAMINATE*		22	

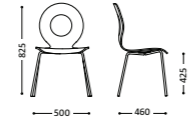
\* Chosen configuration multiply by quantity of seats.

Apart from the product number/code, please specify option symbol, fabric and finish codes to complete an order.

stacking max. no of pcs	card box diameter [m]	no. of pcs per card box	no. of pcs per EURO pallet	no. of pcs per 1200 x 1000mm pallet	net weight [kg]	seat of chair - width [mm]	seat of chair - depth [mm]	MODEL [mm]		
										
4	0.32	4		32	4.9	450	500			<b>CAFE IX alu&amp;bl</b> CAFE-IX 4L-zz xx GB
4	0.33	4		32	4.5	390	430			<b>CAFE XII alu/bl</b> CAFE-XII 4L-zz WOOD-xx GB

Price	
PLYWOOD	
	126
	127

OPTIONS FOR PLYWOOD CAFE CHAIRS				
DESCRIPTION	VERSIONS	GROUP 0 (M, V, C)	GROUP 1 (BN, YB, EF, SM, KN)	GROUP 2 (YN, CM, UNY, VL, XR, CSE)
Seat with upholstered cushion, wooden backrest	SEAT PLUS	13	16	19
Cafe stacking cushion			25	
4-leg frame	CR&RAL (pg. 141)		6	
4-leg frame with armrests			10	
Wood stain with slightly visible wood grain on backrest and seat			13	
Laminated wood components with natural edge, protected with wax	LAMINATE		22	
Black glides with felt for hard surfaces (available with frames: 4L, 4L-ARM, CFS, Hocker, SQ)	GBF		3	
White glides (available with frames: 4L, 4L-ARM)	GW		3	

Apart from the product number/code, please specify option symbol, fabric and finish codes to complete an order.

stacking max. no of pcs	card box diameter [m]	no. of pcs per card box	no. of pcs per EURO pallet	no. of pcs per 1200 x 1000mm pallet	net weight [kg]	seat of chair - width [mm]	seat of chair - depth [mm]	MODEL [mm]		3 YEARS WARRANTY	
								Technical drawing 1	Technical drawing 2		
4	0.38	4		32	4.9	470	430				<b>LAKKA alu &amp; bl</b> LAKKA 4L-zz xxGB
4	0.38	4		32	4.8	395	425				<b>LANTANA alu &amp; bl</b> LANTANA 4L-zz xx GB
4	0.45	4		32	6.2	395	425				<b>LANTANA arm alu &amp; bl</b> LANTANA 4L-ARM/Front-zz NF-xx xx GB
8	0.35	4		32	5.5	395	425				<b>SQUERTO alu &amp; bl</b> SQUERTO 4L-zz xx GB
4	0.38	4		32	4.8	395	425				<b>VERBENA alu &amp; bl</b> VERBENA 4L-zz xx GB
4	0.45	4		32	6.2	395	425				<b>VERBENA arm alu &amp; bl</b> VERBENA 4L-ARM/Front-zz NF-xx xx GB

Price	
PLYWOOD	
	154
	154
	194
	173
	154
	194

OPTIONS FOR PLYWOOD CAFE CHAIRS				
DESCRIPTION	VERSIONS	GROUP 0 (M, V, C)	GROUP 1 (BN, YB, EF, SM, KN)	GROUP 2 (YN, CM, UNY, VL, XR, CSE)
Seat with upholstered cushion, wooden backrest	SEAT PLUS	13	16	19
Seat and back with upholstered cushions (SQUERTO)	PLUS	32	37	43
Fully upholstered seat and backrest (SQUERTO)	A PLUS	35	40	46
Front part of the chair fully upholstered (SQUERTO)	B PLUS	46	51	57
Cafe stacking cushion			25	
4-leg frame (only LANTANA, VERBENA)	CR&RAL (pg. 141)		6	
4-leg frame with armrests (only LANTANA, VERBENA)			10	
SQUERTO frame	CR&RAL (pg. 141)		22	
Wood stain with slightly visible wood grain on backrest and seat			13	
Laminated wood components with natural edge, protected with wax	LAMINATE		22	
Black glides with felt for hard surfaces (available with frames: 4L, 4L-ARM, CFS, Hocker, SQ)	GBF		3	
White glides (available with frames: 4L, 4L-ARM)	GW		3	
SQUERTO STACKING CUSHION (only for upholstered versions)			16	

Apart from the product number/code, please specify option symbol, fabric and finish codes to complete an order.



stacking max. no of pcs	card box diameter [m]	no. of pcs per card box	no. of pcs per EURO pallet	no. of pcs per 1200x1000mm pallet	net weight [kg]	seat of chair - width [mm]	seat of chair - depth [mm]	MODEL [mm]			3 YEARS WARRANTY
8	0.37	4		24	5.7	420	440				<b>WING II alu&amp;bl</b> WING-II 4L-zz xx GB
8	0.37	4		24	5.7	420	440				<b>WING II click alu&amp;bl</b> WING-II-CLICK 4L-zz xx GB
10	0.46	4	16		5.7	400	430				<b>WING II cfs alu&amp;bl</b> WING-II CFS-zz xx GB
8	37	4		24	5.7	420	440				<b>WING II cfl alu&amp;bl*</b> WING CFL-zz xx GB

\*WING II cfl - stacking only plywood version

Price	
PLYWOOD	
	152
	155
	157
	184

EXTRA CHARGE FOR OTHER VERSIONS					
DESCRIPTION	VERSIONS	GROUP 0 (M, V, C)	GROUP 1 (BN, YB, EF, SM, KN)	GROUP 2 (YN, CM, UNY, VL, XR)	GROUP 3 (OX)
Seat with upholstered cushion, wooden backrest	SEAT PLUS	13	16	19	24
Seat and backrest with upholstered cushions	PLUS	24	30	37	45
4-leg frame	CR			6	
CFS frame	CR			6	
CFL frame	CR			30	
CLICK (available with 4L frame)	CLICK			3	
CLICK-J4 (available with W frame)	CLICK-J4			40	
Wood stain with slightly visible wood grain on backrest and seat				13	
Laminated wood components with natural edge (WING II)	LAMINATE			22	
Glides with felt for hard surfaces (available with frames: 4L, W)	GBF			3	

Apart from the product number/code, please specify option symbol, fabric and finish codes to complete an order.





stacking max. no of pcs	card box diameter [m]	no. of pcs per card box	no. of pcs per EURO pallet	no. of pcs per 1200 x 1000mm pallet	net weight [kg]	seat of chair - width [mm]	seat of chair - depth [mm]	MODEL [mm]	
									
8	0.35	4		32	5.7	420	440	<b>WING II TR chrome</b> WING-II 4L-CR NF-xx wood-xx TR-xx GB	
8	0.37	4		32	6.4	420	565	<b>WING II W alu/bl</b> WING-II-W 4L-xx NF-xx WOOD-xx GB	

Price	
PLYWOOD	
	206
	201

EXTRA CHARGE FOR WING II CHAIRS					
DESCRIPTION	VERSIONS	GROUP 0 (M, V, C)	GROUP 1 (BN, YB, EF, SM, KN)	GROUP 2 (YN, CM, UNY, VL, XR)	GROUP 3 (OX)
Seat with upholstered cushion, wooden backrest	SEAT PLUS	13	16	19	24
Seat and backrest with upholstered cushions	PLUS	24	30	37	45
W chrome	CR			11	
CLICK-J4 (available with W frame)				40	
Wood stain with slightly visible wood grain on backrest and seat				13	
Laminated wood components with natural edge (WING II W)	LAMINATE			22	
Laminated wood components with natural edge (WING II TR)	LAMINATE			30	
Tablet for left-handed	TL			without extra charge	
Glides with felt for hard surfaces (WING II TL)	GBF			3	

Apart from the product number/code, please specify option symbol, fabric and finish codes to complete an order.

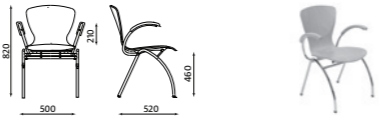
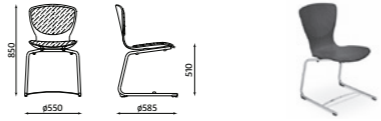
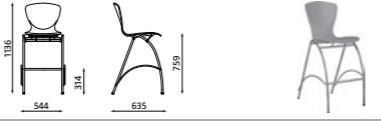

stacking max. no of pcs	card box diameter [m]	no. of pcs per card box	no. of pcs per EURO pallet	no. of pcs per 1200x1000mm pallet	net weight [kg]	seat of chair - width [mm]	seat of chair - depth [mm]	MODEL [mm]	
4	0.42	4		24	6.3	445	455	 BINGO wood alu & bl BINGO 4L-zz xx GB	
								 BINGO Link Link-plastic 20	
4	0.5	4		24	7.4	445	455	 BINGO arm wood alu & bl BINGO 4L-ARM-zz NF-xx xx GB	
4	0.4	3	12		7.8	445	455	 BINGO CFL alu & bl* BINGO CFL-zz WOOD-xx GB	
4	0.5	2	8		9	445	455	 BINGO HOCKER wood alu & bl BINGO HOCKER-zz xx GB	
	0.19	1	10		13.5	445	455	 BINGO GTP BINGO ST21-CR GTP-CR-xx PST45-BL WOOD-xx SH	

\*BINGO CFL - stacking only plywood version

Price Group
PLYWOOD
176
8
230
227
258
325

EXTRA CHARGE FOR BINGO CHAIRS					
DESCRIPTION	VERSIONS	GROUP 0 (M, V, C)	GROUP 1 (BN, YB, EF, SM, KN)	GROUP 2 (YN, CM, UNY, VL, XR, CSE)	GROUP 3 (OX)
Seat with upholstered cushion, wooden backrest	SEAT PLUS	13	16	19	24
Seat and backrest with upholstered cushions	PLUS	24	30	37	45
4-leg frame	CR			6	
4-leg frame with armrests	CR			10	
CFL frame	CR			30	
4 legs Hocker frame	CR			10	
Wood stain with slightly visible wood grain on backrest and seat				13	
Laminated wood components with natural edge, protected with wax	LAMINATE*			22	
Link to connect front and back legs	LINK			8	
Glides with felt for hard surfaces (available with frames: 4L, 4L-ARM)	GBF			3	

\*When ordering the ARM laminate version, please note that the armrests are coated with wood stain. Laminate and wood stain can be chosen from the standard offer of finishes.

Apart from the product number/code, please specify option symbol, fabric and finish codes to complete an order.

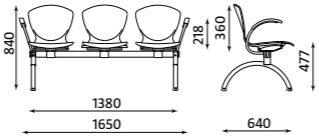
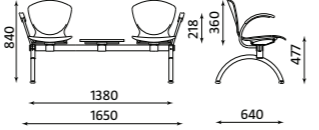
stacking max. no of pcs	card box diame- ter [m]	no. of pcs per card box	no. of pcs per EURO pallet	no. of pcs per 1200x1000mm pallet	net weight [kg]	seat of chair - width [mm]	seat of chair - depth [mm]	MODEL [mm]	
									
0.18	1	10			28.7	445	450		<b>BINGO-3 arm wood alu &amp; bl</b> BINGO-3 A-ALU ARM-zz-xx WOOD-xx GB
0.18	1	10			38	445	450		<b>BINGO-3/T arm wood alu &amp; bl</b> BINGO-3 A-ALU ARM-zz-xx WOOD-xx-xx T-NB GB

Price Group
PLYWOOD
554
506











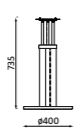

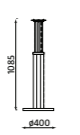



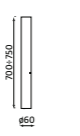

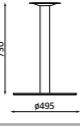
EXTRA CHARGE FOR BINGO CHAIRS					
DESCRIPTION	VERSIONS	GROUP 0 (M, V, C)	GROUP 1 (BN, YB, EF, SM, KN)	GROUP 2 (YN, CM, UNY, VL, XR, CSE)	GROUP 3 (OX)
Seat with upholstered cushion, wooden backrest	SEAT PLUS*	13	16	19	24
Seat and backrest with upholstered cushions	PLUS*	24	30	37	45
Bench ARM	CR/ALU BEAM			30	
Wood stain with slightly visible wood grain on backrest and seat				13	
Laminated wood components with natural edge, protected with wax	LAMINATE**			22	
BINGO CONNECTOR to connect benches 2 pcs in a set	LINK			6	
Glides with felt for hard surfaces (available with frames: Bench, Bench ARM)	GBF			41	

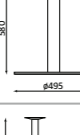

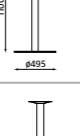

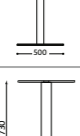



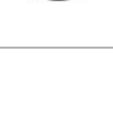

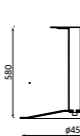

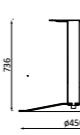

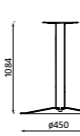
\* Chosen configuration multiply by quantity of seats.

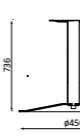
\*\*When ordering the ARM laminate version, please note that the armrests are coated with wood stain. Laminate and wood stain can be chosen from the standard offer of finishes.

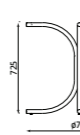
Apart from the product number/code, please specify option symbol, fabric and finish codes to complete an order.

# TABLE BASES

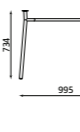
card box diameter [m <sup>3</sup> ]	no. of pcs per card box	no. of pcs per EURO pallet	no. of pcs of 1200x1000mm pallet	net weight [kg]	MODEL [mm]	3 YEARS WARRANTY	PRICE	
0.14	1	12		19.6			BISTRO TABLE alu	264
							BISTRO TABLE chrome	267
0.21	1	12		22			BISTRO TABLE 1100 alu	297
							BISTRO TABLE 1100 chrome	305
0.016	1		70	4.4			KAJA 500 TABLE alu	52
							KAJA 500 TABLE chrome	54
0.02	each leg separately	32		1.7			KAJA alu adjustable 60mm	66
							KAJA chrome adjustable 60mm	80
0.076	1		24	15.3			LARA INOX	227
0.045	1		36	15			LARA INOX 580	202
0.1	1		10	16			LARA INOX 1100	256
0.11	1	7		17			LARA INOX MIX 1100	285
0.045	1		36	20			LARA INOX SQ	257
0.04	2		40				LENA 380 alu	66
							LENA 380 chrome	68

card box diameter [m <sup>3</sup> ]	no. of pcs per card box	no. of pcs per EURO pallet	no. of pcs of 1200x1000mm pallet	net weight [kg]	MODEL [mm]	3 YEARS WARRANTY	PRICE	
0.07	2		18	8			LENA 580 alu	74
							LENA 580 chrome	75
0.07	2		18	8.4			LENA alu	77
							LENA chrome	78
0.26	2		16	8.8			LENA 1100 alu	114
							LENA 1100 chrome	120
0.07	2		18	8.4			LENA OUTDOORS	121
0.05	1	26		4.1			ROZANA alu	73
							ROZANA chrome	83
0.09	1	20		5.5			TIRAMISU TABLE alu	123
							TIRAMISU TABLE chrome	129
0.09	1	20		6.2			TIRAMISU DUO TABLE aluminum	124
							TIRAMISU DUO TABLE chrome	132

# TABLES







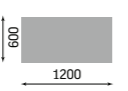

card box diameter [m]	no. of pcs per card box	no. of pcs per EURO pallet	net weight [kg]	MODEL [mm]	3 YEARS WARRANTY	PRICE (melamine board table top)
0.07	1	pallet 1700x800: 20	15.2		ERYK chrome 1200x500	254
0.07	1	pallet 1700x800: 20	18		ERYK chrome 1200x600	265
0.07	1	pallet 1700x800: 20	25.6		ERYK chrome 1200x800	276
0.19	1	pallet 1900x900: 10	31.2		ERYK chrome 1600x800	352
0.22	1	pallet 1900x900: 10	34.3		ERYK chrome 1800x800	378
0.23	1	pallet 2100x900: 10	39.9		ERYK chrome 2000x800	400
0.09	1	pallet 1650x800: 20	24.5		RICO TABLE-2 alu	199
					RICO TABLE-2 black	199
0.1	1	pallet 1900x900: 20	27		RICO TABLE-3 alu	213
					RICO TABLE-3 black	213
0.12	1	pallet 2100x900: 20	30		RICO TABLE-4 alu	230
					RICO TABLE-4 black	230
0.23	1	6	21		RICO Cart	794

Tables available with NB table tops, other colours of tops will be available with longer production time.

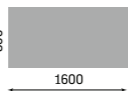
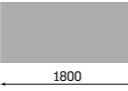
# CRUZO - TABLE BASE

card box diameter [m]	no. of card boxes per pcs	no. of pcs per EURO pallet	net weight [kg]	MODEL [mm]	3 YEARS WARRANTY	PRICE	
						ALU	CHROME
0.071	1	15	7.6		CRUZO LARGO	160	225
0.060	1	pallet 1400x800: 20	9.5		CRUZO LARGO 1800	170	237
0.051	1	pallet 1200x1000: 20	3.9		CRUZO Ø600	104	135
0.046	1	pallet 1200x1000: 20	7.5		CRUZO Ø800	140	190
0.046	1	pallet 1200x1000: 20	4.5		CRUZO 1100 Ø600	124	167



# CRUZO - TABLE TOP

card box diameter [m <sup>2</sup> ]	no. of card boxes per pcs	no. of pcs per EURO pallet	net weight [kg]	MODEL [mm]	PRICE		
					MELAMINE (MA)	LAMINATE (LL)	TOPALIT (TP)
0.020	1	pallet 1250×800: 40	LL: 11.30 MA: 12.30	 CRUZO LARGO 1200×600	74	201	-
0.029	1	pallet 1250×850: 40	LL: 15.00 MA: 16.30	 CRUZO LARGO 1200×800	88	236	-
0.040	1	25	TP: 15.20		-	-	244
0.040	1	pallet 1450×850: 30	LL: 17.50 MA: 19.10	 CRUZO LARGO 1400×800	131	286	-
0.047	1	pallet 1650×850: 30	LL: 20.00 MA: 21.80	 CRUZO LARGO 1600×800	157	335	-
0.044	1	pallet 1850×850: 25	LL: 22.50 MA: 24.50	 CRUZO LARGO 1800×800	194	380	-
0.009	1	pallet 1250×800: 80	LL: 4.40 MA: 4.80	 CRUZO Ø600	55	109	-
0.010	1		TP: 4.30		-	-	74
0.019	1	pallet 1200×850: 40	LL: 7.90 MA: 8.50	 CRUZO Ø800	74	191	-
0.030	1	32	TP: 7.60		-	-	104
0.016	1	pallet 1200×850: 40	LL: 10.00 MA: 10.90	 CRUZO 800×800	70	183	-
0.030	1	32	TP: 10.00		-	-	155
0.030	1	pallet 1200×1200: 40	LL: 11.70 MA: 13.50	 CRUZO Ø1000	156	322	-
0.044	1	pallet 1250×1250: 35	LL: 16.90 MA: 19.20	 CRUZO Ø1200	170	344	-





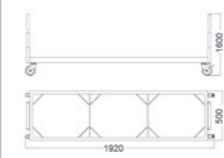



# CRUZO - CONFIGURATION

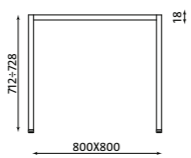

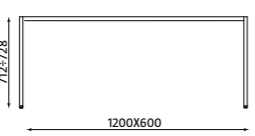

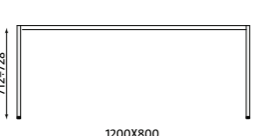

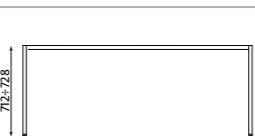

Cruzo table bases [mm]	Cruzo table tops [mm]									
	Ø 600	800×800	Ø 800	Largo 1200×600	Largo 1200×800	Largo 1400×600	Largo 1600×800	Largo 1800×800	Ø 1000	Ø 1200
Ø 600	x									
1100 Ø 600	x									
Ø 800		x	x							
1100 Ø 800		x	x							
Largo				x	x	x	x			
Largo 1800								x		
Ø 1000									x	x

## ISO CART







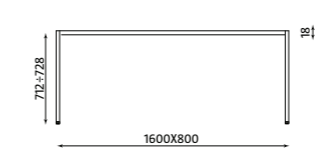

card box diameter [m <sup>2</sup> ]	no. of card boxes per pcs	no. of pcs per EURO pallet	net weight [kg]	MODEL [mm]	PRICE
			24	  <p>ISO CART (enables stacking and transporting up to 30 pcs.)</p>	707

## TABLE - SIMPLE

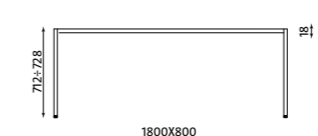
stacking max. no of pcs	card box diameter [m3]	no. of pcs per card box	no. of pcs per EURO pallet	net weight [kg]	MODEL [mm]	3 YEARS WARRANTY	PRICE melamine board table top
20	0.04	1	20	17.7	 SIMPLE 80×80/RAL-xx/MA-xx	196	196
					 SIMPLE 80×80/C/B/MA-xx		221
20	0.05	1	20	20	 SIMPLE 120×60/RAL-xx/MA-xx	199	199
					 SIMPLE 120×60/C/B/MA-xx		224
20	0.07	1	30.1	30.1	 SIMPLE 120×80/RAL-xx/MA-xx	230	230
					 SIMPLE 120×80/C/B/MA-xx		254
20	0.08	1	20	26	 SIMPLE 140×80/RAL-xx/MA-xx	257	257
					 SIMPLE 140×80/C/B/MA-xx		282

SHAPE	DIMENSIONS [mm]	TABLE TOP COLOUR	FRAME and LEGS COLOUR	SHAPE	DIMENSIONS [mm]	TABLE TOP COLOUR	FRAME and LEGS COLOUR
	800×800	Tables available with NB table tops, other colours of tops will be available with longer production time.	RAL 7035 (light grey)		1600×800	Tables available with NB table tops, other colours of tops will be available with longer production time.	RAL 7035 (light grey)
	1200×600		RAL 7021 (dark grey)		1800×800		RAL 7021 (dark grey)
	1200×800		RAL 9006 (alu)		2000×800		RAL 9006 (alu)
	1400×800		C/B (chrome - legs/black - frame)		1600×800×800		C/B (chrome - legs/black - frame)

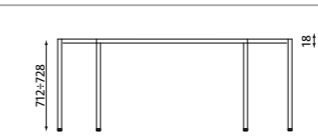



## TABLE - SIMPLE

stacking max. no of pcs	card box diameter [m3]	no. of pcs per card box	no. of pcs per EURO pallet	net weight [kg]	MODEL [mm]	3 YEARS WARRANTY	PRICE melamine board table top
20	0.09	1	28.8	28.8	 SIMPLE 160×80/RAL-xx/MA-xx	285	285
					 SIMPLE 160×80/C/B/MA-xx		309
20	0.1	1	31.3	31.3	 SIMPLE 180×80/RAL-xx/MA-xx	312	312
					 SIMPLE 180×80/C/B/MA-xx		337
20	0.11	1	34	34	 SIMPLE 200×80/RAL-xx/MA-xx	330	330
					 SIMPLE 200×80/C/B/MA-xx		356
20	0.08	1	16.4	16.4	 SIMPLE 160×80/RAL-xx/MA-xx	272	272
					 SIMPLE 160×80×80/C/B/MA-xx		304



### EXAMPLES

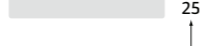

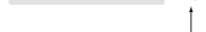

## STANDARD MELAMINE TABLE TOPS (ABS edge in the colour of the table top surface)





card box diameter [m]	no. of pcs per card box	no. of pcs per EURO pallet	net weight [kg]	SHAPE	SIZE [mm]	PROFILE [mm]	PRICE CA, BT, BO, BS, BW, DD, DA, FL, GW, IH, II, IJ
0.02	1	100	4.5	●	Ø600		58
0.03	1	50	5.6	●	Ø800		77
0.03	1	50	8.5	■	800×800		74
0.03	1	50	16.8	■	800×1200		88
0.03	1	50	8.2	■	800×600 only for Kaja table		56

## TOP 36 MELAMINE TABLE TOPS (aluminum edge)





card box diameter [m]	no. of pcs per card box	no. of pcs per EURO pallet	net weight [kg]	SHAPE	SIZE [mm]	PROFILE [mm]	PRICE NT, BI, CC, NH, NV
0.03	1	60	5.1	●	Ø600		117
0.05	1	30	9.1	●	Ø800		156
0.05	1	30	10.8	■	800×800		156

## TOP 50 MELAMINE TABLE TOPS (ABS edge in the colour of the table top surface)

card box diameter [m]	no. of pcs per card box	no. of pcs per EURO pallet	net weight [kg]	SHAPE	SIZE [mm]	PROFILE [mm]	PRICE BI, CC, NH
0.03	1	60	7.2	●	Ø600		102
0.05	1	30	12.2	●	Ø800		146
0.05	1	30	14.9	■	800×800		143

card box diameter [m]	no. of pcs per card box	no. of pcs per EURO pallet	no. of pcs per 1200×1000mm pallet	gross weight [kg]	SHAPE	SIZE [mm]	PROFILE [mm]	PRICE W.001, W.107, W.009, W.011, W.019, W.034, W.038, W.055, W.074, W.077, W.106, W.137, W.214, W.218
0.01	1			4.3	●	Ø600		74
0.03	1	32		7.6	●	Ø800		104
0.03	1	32		10	■	800×800		155
0.04	1	25		15.2	■	800×1200		244

## LAMINATED TABLE TOPS

card box diameter [m]	no. of pcs per card box	no. of pcs per EURO pallet	no. of pcs per 1200×1000mm pallet	gross weight [kg]	SHAPE	SIZE [mm]	PROFILE [mm]	PRICE CA, BR, BS, BT, BO, BW, DE, DS, DD, IH, II, IJ
0.02	1	100	7.5	4.5	●	Ø600		112
0.03	1	50	1.1	5.6	●	Ø800		195
0.03	1	50	13.5	8.5	■	800×800		187
0.03	1	50	2.5	16.8	■	800×1200		236











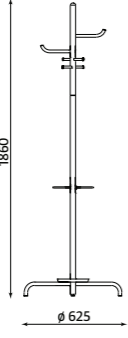



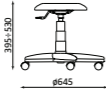

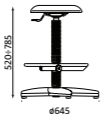







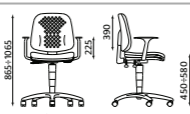
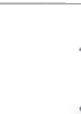





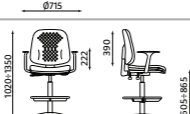

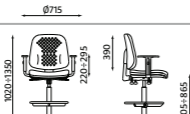
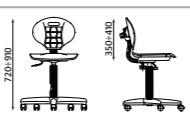

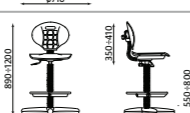
card box diameter [m]	no. of pcs per card box	no. of pcs per EURO pallet	no. of pcs of 1200×1000 mm pallet	net weight [kg]	MODEL [mm]	PRICE
0.03	1		40	6.4	 ARIZONA alu&black	85
					 ARIZONA chrome&RAL (pg. 141)	107
0.08	1		26	11.1	 TOP chrome	163

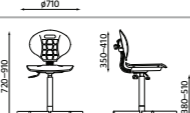
TABLE TOPS		TABLE BASES															
Shapes and dimensions of table tops		BISTRO	BISTRO 1100	KAJA	KAJA 500	LARA INOX 580	LARA INOX	LARA INOX 1100	LARA INOX MIX 1100	LARA INOX SQ	LENA 380	LENA 580	LENA	LENA 1100	LENA OUTDOORS	ROZANA	TIRAMISU DUO
Table tops Topalit	Ø 600	•	•		•	•	•	•	•		•	•	•	•	•		
	Ø 800	•		•	•	•	•						•		•		
	800×800			•	•					•						•	
	800×1200			•	•												•
Table tops made of melaminated chipboard	Ø 600	•	•		•	•	•	•	•		•	•	•	•			
	Ø 800	•		•	•	•	•						•				
	600×800				•												
	800×800			•	•					•						•	
800×1200			•	•												•	
Top 36 & Top 50 made of melaminated chipboard	Ø 600	•	•		•	•	•	•	•		•	•	•	•			
	Ø 800	•		•	•	•	•						•				
	800×800			•	•					•						•	
Table tops made of laminated chipboard	Ø 600	•	•		•	•	•	•	•		•	•	•	•			
	Ø 800	•		•	•	•	•						•				
	800×800			•	•					•						•	
	800×1200			•	•												•

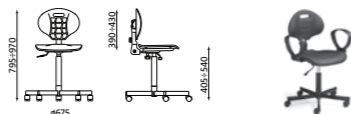

card box diameter [m3]	no. of pcs per card box	no. of pcs per EURO pallet	no. of pcs per 1200 x 1000 mm pallet	net weight [kg]	seat of chair -		MODEL [mm]	
					width [mm]	depth [mm]		
0.07	1	28		6.5	Ø 360		 	<b>GOLIAT ts02</b> GOLIAT-PU TS02 PST00S-BL SH
0.08	1	28		8.5	Ø 360		 	<b>GOLIAT ts02 + Ring Base</b> GOLIAT-PU-RB-CR TS02 PST00S-BL GB
0.07	1	28		6.5	Ø 360		 	<b>GOLIAT ts12</b> GOLIAT TS12 PST00S-BL SH
0.07	1	28		8.5	Ø 360		 	<b>GOLIAT ts12 + Ring Base</b> GOLIAT-RB-BL TS12 PST00S-BL GB
0.14	1	12			490	450	  	<b>LABO RTS TS02</b> with Ergon Up mechanism LABO RTS TS02 ERGON UP BL SH
0.14	1	12			490	450	  	<b>LABO GTP46 TS02</b> with Ergon Up mechanism LABO GTP46 TS02 Ergon UP BL SH
0.14	1	12			490	450	  	<b>LABO R26S TS02</b> with Ibra mechanism LABO R26S TS02 IBRA BL SH
0.17	1	10			490	450	  	<b>LABO RTS TS06 + Ring Base</b> with Ergon Up mechanism LABO-RB-BL TS06 RTS ERGON UP BL GB
0.17	1	10			490	450	  	<b>LABO GTP46 TS06 + Ring Base</b> with Ergon Up mechanism LABO-RB-BL TS06 GTP46 ERGON UP BL GB
0.17	1	10			490	450	  	<b>LABO R26S TS06 + Ring Base</b> with Ibra mechanism LABO-RB-BL TS06 R26S SYNCROIBRA BL GB
0.08	1	24		10	460	440-470	  	<b>NARGO RTS ts13</b> NARGO TS13 RTS PST01-OW SH
0.08	1	24		11.9	460	440-470	  	<b>NARGO RTS ts13 + Ring Base</b> NARGO-RB-BL TS13 RTS PST01-OW GB
0.08	1	24			460	440-470	  	<b>NARGO RTS steel26</b> with a CPT mechanism NARGO ST26-BL RTS PST01-CPT GB

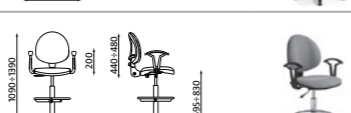
	Price Group			
	PLASTIC OR PLYWOOD	GROUP 0 (V, C)	GROUP 1 (BN, YB, EF, SM, KN)	GROUP 2 (YN, UNY, XR)
111				
152				
		92		
		125		
329				
355				
437				
382				
408				
491				
180				
212				
188				

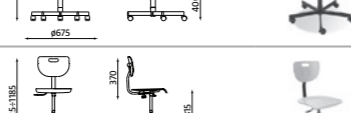
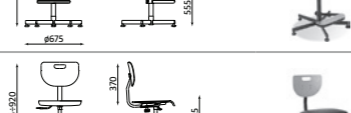
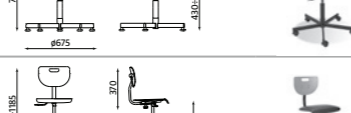
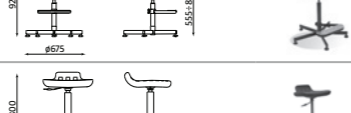
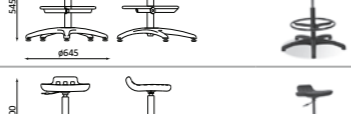
card box diameter [m3]	no. of pcs per card box	no. of pcs per EURO pallet	no. of pcs per 1200x1000mm pallet	net weight [kg]	seat of chair - width [mm]	seat of chair - depth [mm]	MODEL [mm]	
0.08	1	24			460	440-470	 NARGO-RB-BL ST26-BL RTS PST01-CPT GB	
0.08	1	24			460	440-470	 NARGO ST26-BL GTP2 PST01-CPT SH	
0.10	1	20		10.3	440	395-420	 SENIOR-RB-BL TS12 RTS PST03-OW xx GB	
0.10	1	pallet 1200x800: 20		10.5	460	425-465	 SMART-RB-BL TS02 RTS PST01-OW xx GB	
0.15	1	pallet 1200x800: 12		13.5	460	425-465	 SMART-RB-CR ST02-CR GTP27 PST01-CPW xx GB	
0.09	1	24		8.1	405	405	 WEREK ST26-BL PST03-OW xx SH	
0.09	1	24		10	405	405	 WEREK-FB ST26-BL PST03-OW xx GB	
0.09	1	24		8.1	415	420	 WEREK ST26-BL PST03-OW BA-xx SE-xx SH	
0.09	1	24		10	405	405	 WEREK-FB ST26-BL PST03-OW BA-xx SE-xx GB	
0.09	1	24		7.4	350	345	 WORKER-RB-BL TS02 PST45-BL GB	
0.09	1	24		8.4	350	345	 WORKER-RB-CR ST01-CR PST45-BL GB	

PLASTIC OR PLYWOOD	Price Group		
	GROUP 0 (V, C)	GROUP 1 (BN, YB, EF, SM, KN)	GROUP 2 (YN, UNY, XR)
245			
203			
	141		
	143	154	159
	215	218	223
139			
172			
	131		
	164		
186			
213			

# FINISHES

**0** PRICE GROUP

## C | Basic Fabric

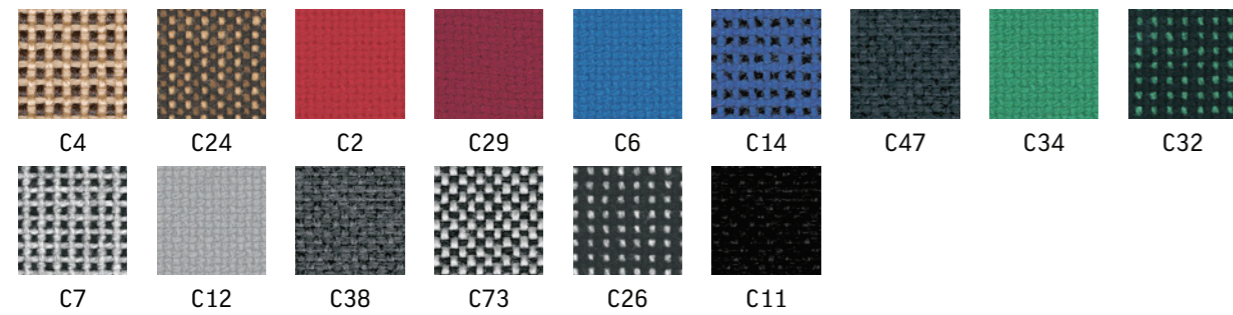

## V | Imitation leather



## M | Micro



# FINISHES

PRICE GROUP **1**

## Bondai | BN



## Kaiman | KN



## Lucia | YB



## Oban | EF

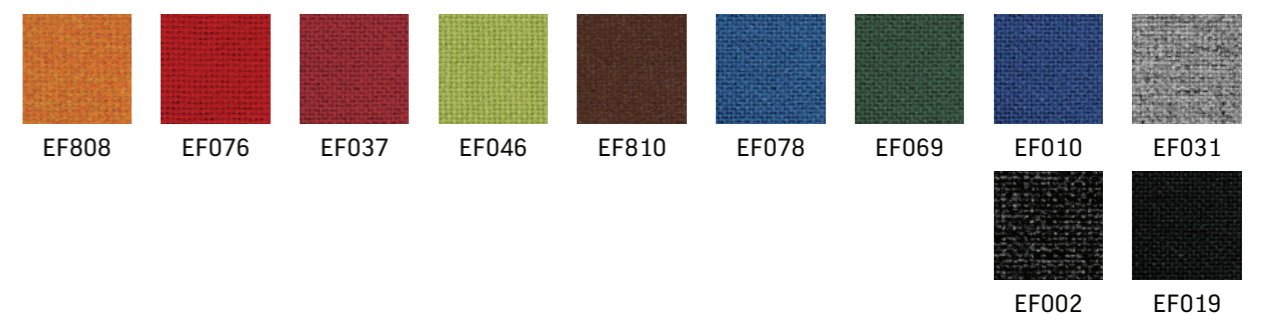

# FINISHES

## SM | Sempre

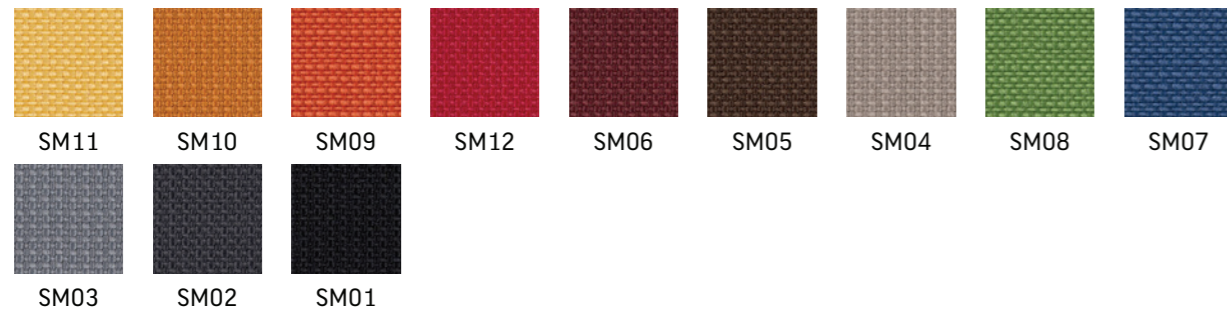

### 2 PRICE GROUP

## CSE | Era



## YN | Contract



## CM | Microfibr



## UNY | Nexus

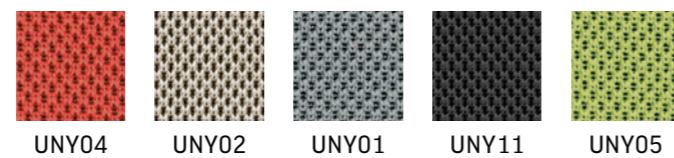

## VL | Valencia



# FINISHES

## Xtreme | XR



### 3 PRICE GROUP

## Flex | XF

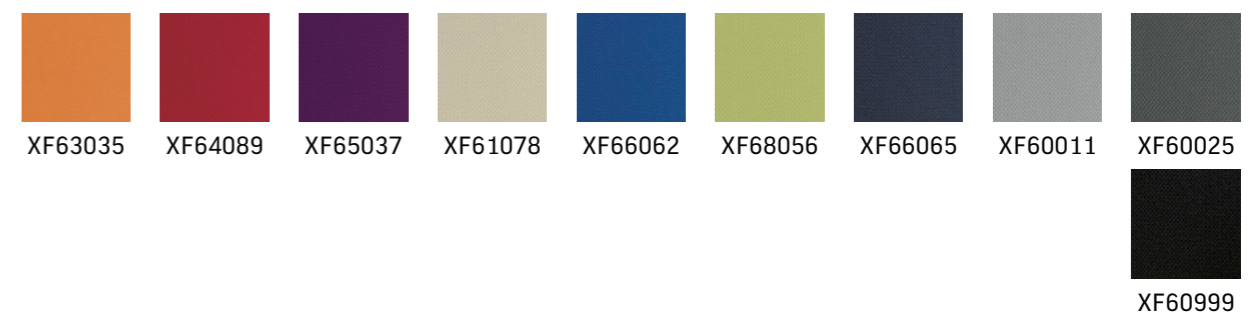

## King L Elast | K

For Club, Club SQ

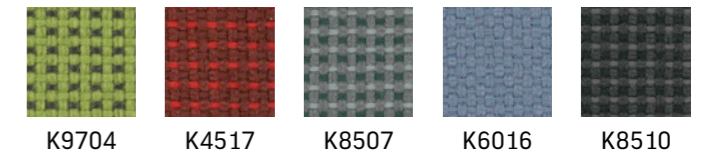

## Oxygen | OX

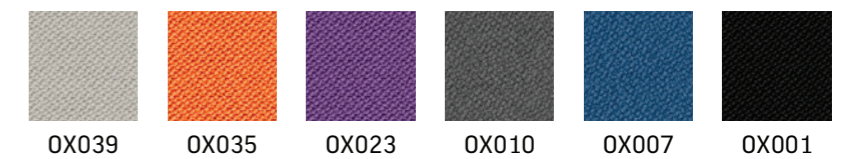

## Silvertex | SX

For Club, Club SQ

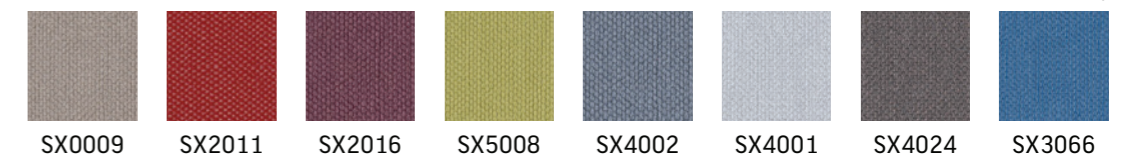

# FINISHES

## RN | Runner

For Montana Plus

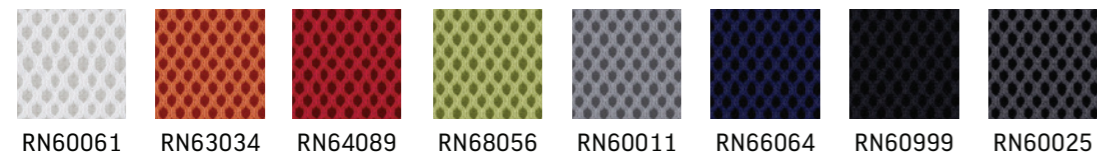

## SP\* | Split Leather SP front



\*Leather front - (front of the chair in leather, back in V imitation leather).

### 4 PRICE GROUP

## CUZ | Blazer

For Club, Club SQ



## F | Fame

For Club, Club SQ

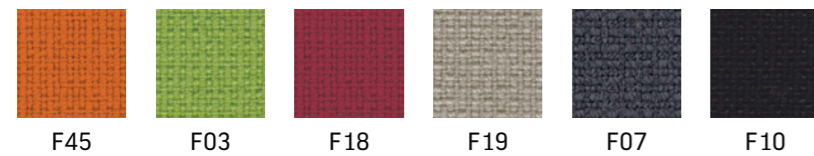

## SD | Fine Leather SD front\*



\* Leather front - (front of the chair in leather, back in V imitation leather).

# FINISHES

## Fine Leather LE | LE\*



\* Leather front - (front of the chair in leather, back in V imitation leather).

## Synergy | LDS



### 5 PRICE GROUP

## Fine Leather LE | LE

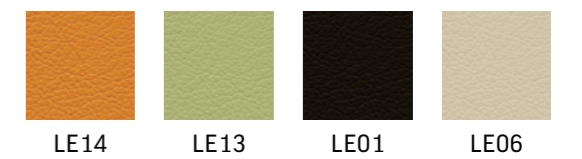

## Fine Leather SD | SD



## Fine Leather Q | Q

For Club, Club SQ



## Mesh

## Mesh | NT

For @-sense

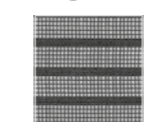

NS01

For Neo-Lux



01

For Officer-Net, Sit.Net, Step, Iso Ergo Mesh, Taktik

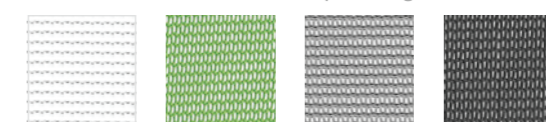

OP20

OP26

OP25

OP24N

For Iso Net, Montana, Rumba

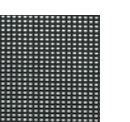

01

Wood & Plywood



☐ Veneer furniture colour matching wood/plywood chair colour:  
 CB Veneer = 1.032 (Colombo)  
 LV Veneer = 1.076 (Havana)  
 BG Veneer = 1.06R (Beech Grey)

Wood stain with slightly visible wood grain



Laminates HPL + 6

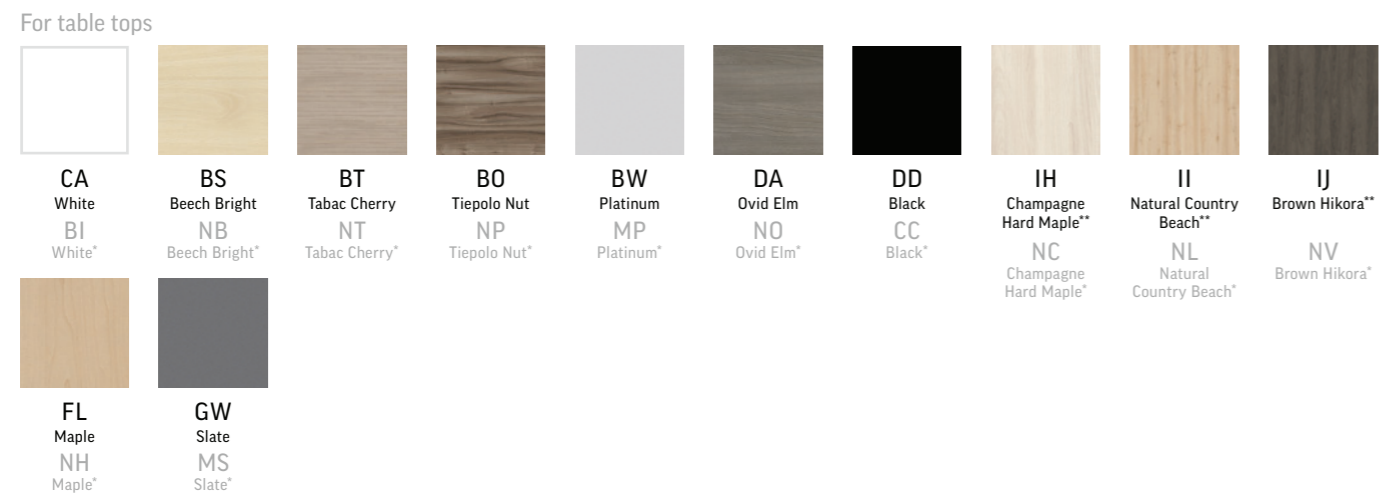

\* Melamine colours matching all above laminate colours.  
 \*\* Available from IIQ 2017

Laminates for chairs and tablets

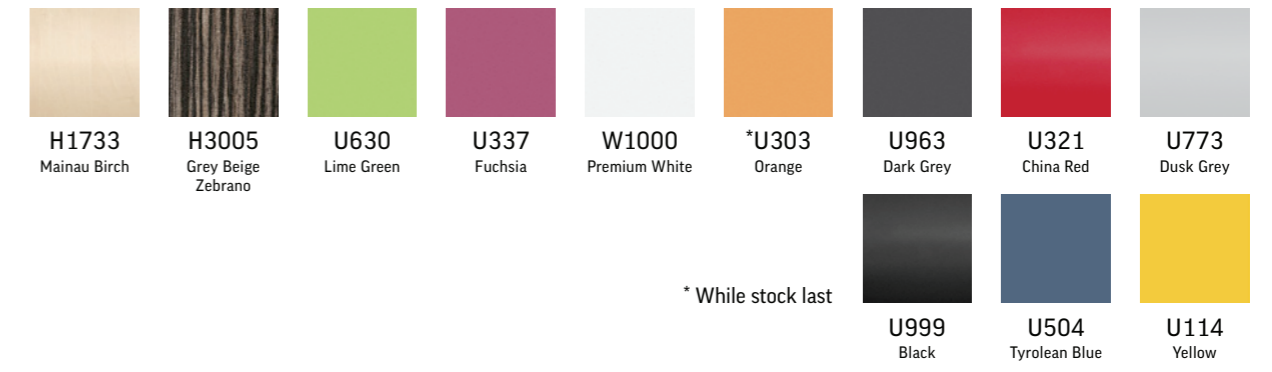

\* While stock last

Melamine

For table tops



\* Available from IIQ 2017

Melamine Top 36

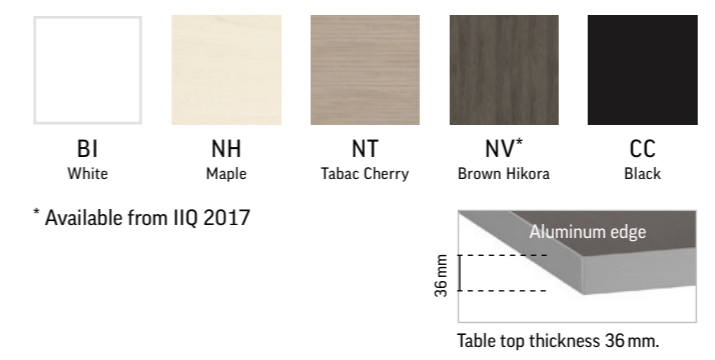

\* Available from IIQ 2017

Melamine Top 50

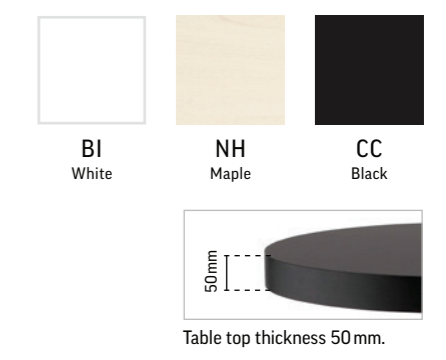

Topalit table top



Resistant to:

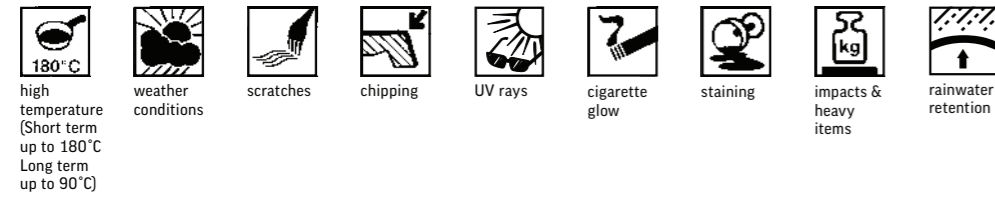

Plastic

For Amigo, Beta, Cortina, Iso, Polyfold

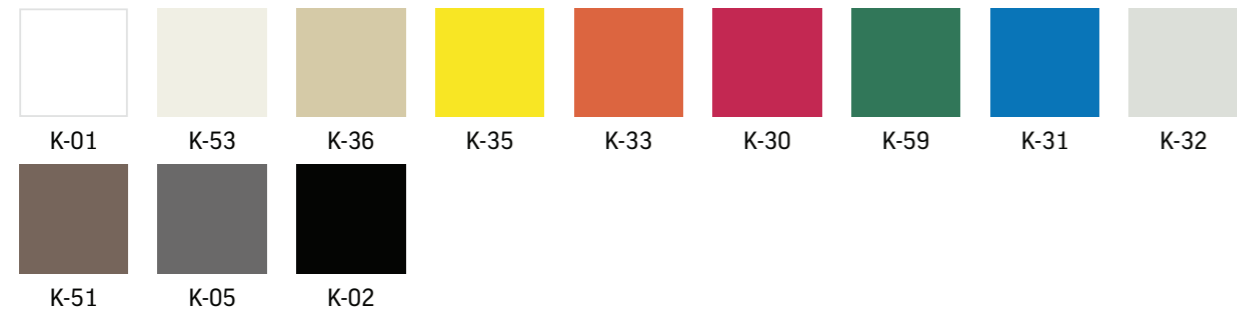

For Polyfold Plus

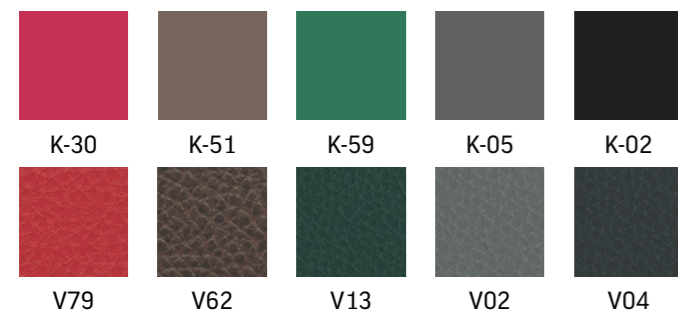

For El Sol

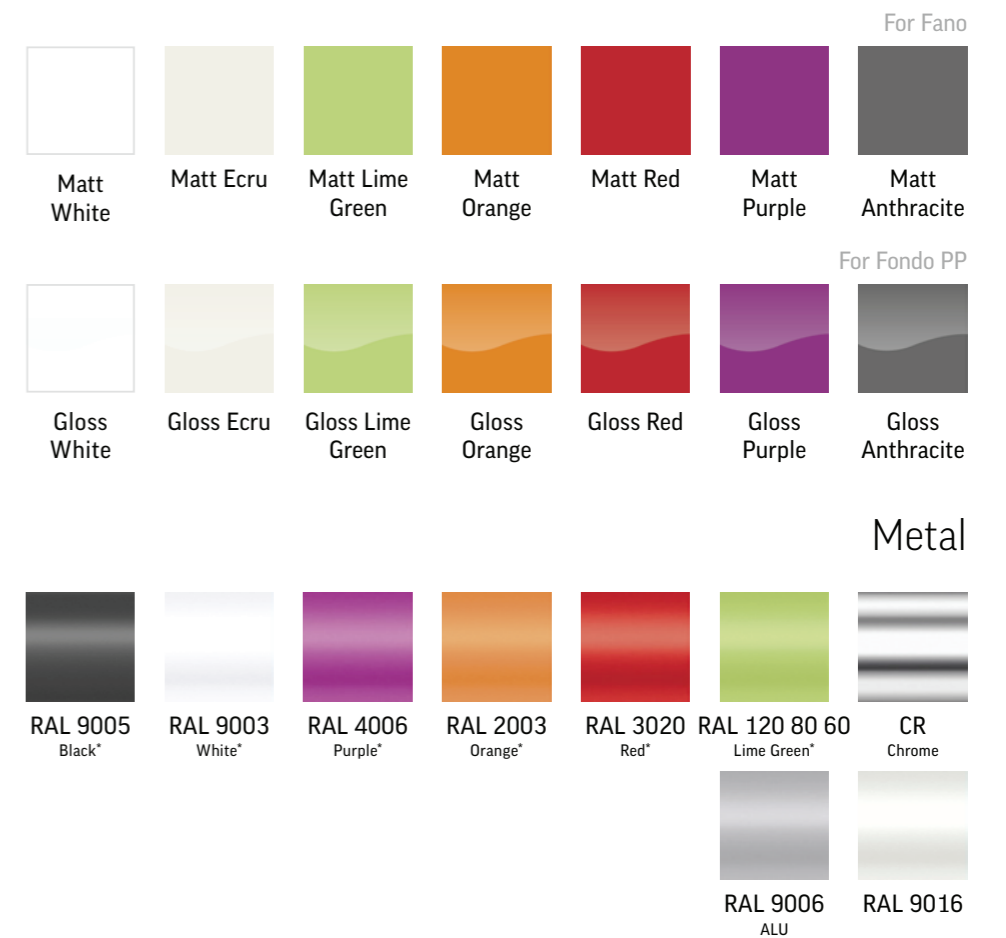
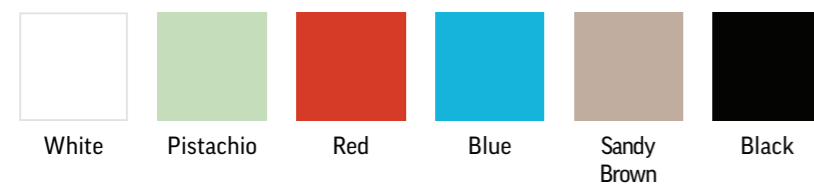

\*Colours available for powder-coated chair frames.

# GENERAL BUSINESS CONDITIONS

## 1. Prices

This pricelist is expressed in EURO and takes effect as of 01/04/2017. All previous pricelists now become invalid. Prices are exclusive of delivery and installation/assembly. The costs of installation will be invoiced at fixed prices. Prices do not include value-added tax. Please note that some chairs are sold assembled. In such situations Nowy Styl Sp. z o.o. (further referred to as NSG) does not charge an additional fee for installation/assembly.

## 2. Orders

All orders must be submitted in a written form to avoid errors or duplication. Orders can be placed via EDI after mutual agreement.

Written orders will be accepted in the form of a signed and approved seller's proposal or in the form of a buyer's purchase order. No phone orders will be accepted. Orders for standard or non-standard products cannot be changed or cancelled once the order has been confirmed in writing by NSG.

## Shipping delays:

Shipping date specified in seller's proposal is seller's best estimation of shipping date at the time of proposal. However, the seller shall not be held responsible to the purchaser for failure to ship by a particular date unless the seller has agreed to an explicit shipping date in a separate written document signed by seller's authorized officer.

## Shipping suspension:

In the event if the purchaser defaults in any payment due to the seller, the seller shall have the right, after prior notice to the purchaser, to defer or discontinue shipment of any goods permanently or until such time as the default is corrected or the purchaser provides assurance of payment in such form, content and/or amount as the seller deems adequate.

## 3. Delivery

Deliveries will take place ex-factory unless otherwise expressly agreed. Products are dispatched wrapped in standard packaging. The goods are delivered according to NSG practice unless specific packing, labeling, marking or means of transporta-

tion are requested by the buyer and confirmed by NSG. The confirmed delivery date is an estimated date only. NSG cannot be held responsible for any loss that the buyer may suffer due to a delayed delivery or lack of delivery.

## 4. Payment

Terms of payment shall be agreed with the buyer. Unless otherwise agreed, payment for a consignment must be effected in accordance with the payment terms indicated on commercial invoice and order confirmation. NSG reserves the ownership of all goods sold which are explicitly described on order confirmation, until the purchase amount has been paid in full. The buyer is responsible to NSG for any damage that the goods sold may suffer, until the goods have been paid for. Unless otherwise agreed, payments shall be made in the currency referenced on the invoice.

Transfer of payments shall be made by electronic means directly to NSG bank account. Should any change occur in buyer's financial and economic position, and NSG deems buyer's solvency situation to be changed, NSG may require immediate or earlier payment.

## 5. Complaints and deficiencies

The buyer is obliged to inspect the consignment immediately upon receipt. Complaints and/or visible damages in transport, if any, shall be specified on delivery note/waybill immediately upon receipt of the goods and shall be reported to the carrier immediately.

Complaints concerning damages in transport that are not visible shall be made in writing and received by NSG no later than 7 days from the date of delivery. The buyer has no right to return goods without NSG approval. Returned goods shall only be accepted if a prior written agreement has been made. The goods should be carefully packaged when being returned.

Once the risk of the goods has passed to the buyer, NSG is no longer responsible for any damage that may occur, with the exception of product liability (injury caused by a defective product manufactured by NSG). NSG cannot be held responsible for any indirect losses, e.g. loss of profits or loss due to time

factors, which the buyer may have suffered as a consequence of defects and deficiencies.

For complaints made within the warranty period NSG demands a description of the defect or deficiency to be made in writing by the customer. In order to file a complaint the customer should contact the person at NSG Customer Service Department who is responsible for the region. The customer is further required to supply a photo supporting the description or to return the product. NSG shall consider the complaint within maximum 7 working days. NSG shall not be liable as specified above if damages have been caused by incorrect or abnormal product use or storage under extreme temperatures and climate conditions, or in case of product use inconsistent with NSG instructions.

## 6. Warranty

Warranty period: 3 or 5 years (applicable to Multi-Purpose Chairs Collection catalogue products). Manufacturer declares that the products shall be free from defects in material or workmanship.

The warranty is given to the original purchaser only, for normal commercial usage. Standard use/normal use is defined as the wear which occurs in an office environment during the course of a normal eight-hour work day with weight limitation not exceeding 110 kg. We will replace, to the original purchaser only, any defects in products, parts or components resulting from normal single-shift use. Natural wear and tear of fabrics, products, parts and components is not covered by the warranty.

The warranty does not cover labour, freight/shipping-handling charges, or damages caused by neglect, abuse, misuse, alterations or damage caused by shipment, fire, flood or other natural disasters.

For detailed information on warranty and maintenance please see next page (141).

## I. General terms

1. Name and address of the Warrantor: Nowy Styl sp. z o.o., ul. Pużaka 49, 38-400 Krosno, Poland.
2. The warranty is an agreement between Nowy Styl sp. z o.o. or another subject belonging to Nowy Styl Group and an entrepreneur who has purchased a product from Nowy Styl sp. z o.o. or another subject belonging to Nowy Styl Group when an invoice or a receipt confirming the purchase clearly includes the possibility of granting a warranty.
3. The transfer of any rights or responsibilities of an entrepreneur resulting from this agreement requires prior consent from Nowy Styl sp. z o.o. that shall be null and void unless given in writing.
4. Nowy Styl sp. z o.o. (hereinafter referred to as "Producer", "Warrantor" or "NS") issues entrepreneurs, in accordance with the conditions defined in this document, a quality warranty for the products purchased from Nowy Styl Group. z o.o. or another subject belonging to Nowy Styl Group by the brands included in an invoice or a receipt confirming a particular purchase (hereinafter referred to collectively as "Products" or individually as "Product").
5. The quality warranty is issued in keeping with the law regulations that are binding in the country in which the sale of the Product to an entrepreneur by Nowy Styl sp. z o.o. or another subject belonging to Nowy Styl Group took place.
6. The geographic scope of the warranty protection: the territory of the country in which the sale of the Product to an entrepreneur by Nowy Styl sp. z o.o. or another subject belonging to Nowy Styl Group took place.
7. In the case of Products manufactured for individual orders, an entrepreneur and Nowy Styl sp. z o.o. or another subject belonging to Nowy Styl Group may agree on different warranty conditions within an agreement that shall be null and void unless made in writing – for instance, a different warranty protection period. In this case the conditions included herein may be valid only partially or may not be valid at all, depending on the prior individual arrangements.
8. The agreement shall not exclude, limit or suspend the following:
  - 8.1. Entitlements resulting from the mandatory provisions of law concerning the responsibility of a seller for the defects of the product sold or those provisions of law concerning a different responsibility system applied to an entrepreneur purchasing Products from Nowy Styl sp. z o.o. or another subject belonging to Nowy Styl Group (hereinafter referred to as "Purchaser"). A Purchaser may exercise the rights attached to a statutory warranty
  - 8.2. for physical defects of products regardless of the rights resulting from the warranty.
  - 8.3. Consumer entitlements defined by the mandatory provisions of law.

## II. The scope of the warranty

1. The responsibility of the Producer resulting from the warranty applies exclusively to those defects that have appeared due to causes inherent in the Product (in particular: material, constructional or manufacturing defects being the fault of the Producer).
2. The warranty covers only those Products that are operated according to the proper use, maintenance and cleaning principles that are published by Nowy Styl sp. z o.o. or another subject belonging to Nowy Styl Group and available on the websites of the Group's brands, at [www.nowystylgroup.com](http://www.nowystylgroup.com) or in assembly manuals provided by the Producer. Violation of any principle results in the warranty rights being lost.
3. Materials used to manufacture the Product that have been supplied by an entrepreneur are not covered by the warranty.

## III. Warranty protection period

1. Nowy Styl sp. z o. o. guarantees the proper quality of the Product within the stated warranty periods dating from the day the Product is purchased by an entrepreneur from Nowy Styl sp. z o.o. or another subject belonging to Nowy Styl Group as confirmed by a VAT invoice or a receipt.
  2. The warranty periods presented in the following conditions have been determined assuming the Products are operated in standard mode, i.e. used by persons working within a single-shift cycle during a 40-hour week (8 hours a day).
  3. Aside from the exceptions defined in the document, the following warranty periods apply to particular groups of Products by the Nowy Styl Group's brands:
    - 3.1. Nowy Styl Standard – 2 years.
    - 3.2. Nowy Styl Premium – 3 years. (Selected Products: Chester, Neo-Lux, Next\_U, Sonata, Cinque, Gem, Montana, Neo II, Officer Net, Offix, Quatro, Wait)
    - 3.3. Nowy Styl – design offer – 5 years. (Selected Products: Enjoy, Sit.On, Sit.Net, Fano, Step, Vesta New)
    - 3.4. BN Office Solution – 5 years.
  4. Exceptions to the stated warranty periods:
    - 4.1. Products upholstered with fabrics from Price Group 0 in NSG's standard offer of finishes – 2 years.
    - 4.2. Products upholstered with fabrics from Price Group 1 in Nowy Styl Group's standard offer of finishes (not applicable to the Nowy Styl Standard offer) – 3 years.
  5. If the Products are used more intensively, i.e. for more than 8 hours a day, the warranty period shall be reduced in proportion to the increased duration of the Product use:
    - 5.1. 8 hours a day (220 working days per year – standard warranty period: 5 years – 60 months).
    - 5.2. 16 hours a day (220 working days per year – warranty period: 2.5 years – 30 months).

# WARRANTY TERMS

- 5.3. 24 hours a day (220 working days per year – warranty period: 1.6 years – 20 months).
- 5.4. 24 hours a day (365 working days per year – warranty period: 1 year – 12 months).
- 5.5. If the Products covered by the 3-year warranty period are used more intensively than 8 hours a day, the warranty period shall be reduced to 2 years (24 months).
- 5.6. In the case of the Products made by the Nowy Styl Standard brand with operation time up to 8 hours a day, the warranty period is 2 years (24 months).
- 5.7. If the Products covered by the 2-year warranty period are used more intensively than 8 hours a day, i.e. they are not used for their intended purpose, the Purchaser loses their warranty rights.

## IV. The responsibilities of the Warrantor, complaint notification

6. Under this warranty and throughout its entire period of validity, pursuant to a legitimate and correctly filed complaint, Nowy Styl sp. z o.o. agrees to do the following, in the stated order: remove a defect or repair the Product or part thereof and, if the above is impossible, replace the Product (or part thereof) with a new one, free from defects.
7. In the case of the Producer withdrawing the product purchased by the Purchaser and for which the warranty is still valid, from production and when the complaint has been submitted within the appropriate time period and accepted, the Purchaser agrees to have the Product exchanged with a new Product whose parameters are as similar as possible to the original Product if the defect removal, Product repair or exchange of its part is not possible.
8. A complaint note must be submitted immediately after a defect is revealed, by means of a complaint form available at <http://portal.partner.pl> or by email directly to [reklamacje@nowystylgroup.com](mailto:reklamacje@nowystylgroup.com), to which a Product purchase form must be attached. Complaints are filed directly with the Nowy Styl Group Customer Service Department or via the Partner portal in the "Transactions" tab.
9. Nowy Styl sp. z o. o. is obliged to confirm that a complaint note has been received within 7 working days of the date of recording the complaint made via a complaint form.
10. Groundless denial of access to examine the Product at the location where it is used, or the conditions in which it is used, or groundless refusal to submit additional information required by Nowy Styl sp. z o. o. results in the warranty rights being lost.
11. The Warrantor is required to investigate the complaint within 60 working days of the day the Product is delivered by the warrantee. In the case of the complaint being accepted, the Warrantor is obliged to perform their duties within 30 working days of the day the complaint is accepted.
12. The warranty period does not run anew (i.e. it is continued) from the day the Product free from defects or the repaired Product is supplied.



## The warranty does not cover the following:

1. Characteristic marks, discolouration or pores, which may appear on leather-upholstered Products naturally (as a consequence of material ageing) as well as the Product wear resulting from a natural process, such as the change of colour of furniture components caused by prolonged exposure to light.
2. Slight variations of surface colour of Products made of wood or finished in natural veneer
3. Minor displacements of the symmetry of wood ring patterns, or the presence of morphological elements in wood, such as knots.
4. Minor variations in the colours of individual components within one Product, or differences between individual pieces of furniture or individual purchase orders.
5. The change of colour or gloss occurring in Products naturally, caused by the inevitable process of ageing.
6. Inconveniences resulting from natural characteristics of raw materials used for production, such as a peculiar smell, which can become intense when more Products are gathered in a small and confined space.
7. Minor differences in fabric colours, as compared to the colours of cuttings and

samples, as these depend on the delivery of a specific batch of fabrics.

8. Dents, scratches, blisters and other defects of glass tops, invisible from a distance of 1 m when looking at a 60 degree angle. Glass shall be assessed in diffused daylight (intensity 500-700 lux), against a bright uniform background, observed with the naked eye.
9. Damage to Products caused by sharp objects, stationery or chemical substances.
10. Differences between the actual dimensions of Products and those specified in a catalogue, if not exceeding 2%.
11. Folds, glossy areas, worn areas, colour changes and other visible signs of the use of Products. The weight and warmth of the human body and the humidity of the environment in which a piece of furniture is used may cause permanent changes to the look of the leather of which Products are made.
12. Change in the look of leather, leather-like fabrics and light-coloured fabrics caused by contact with other materials, the colour of which is inadequately fixed.
13. Heterogeneities visible on leather that prove the natural origin of that material. This includes, primarily: scars, veins, insect

sting pores, variations of colour shades and the structure of glossy areas.

## The following situations are excluded from the warranty:

1. The slightly crumpled fabric in a Product in which upholstery is not glued to the seat and/or backrest.
2. The Product repair has been attempted by unauthorised persons or the Purchaser has interfered with the construction
3. of the Product or has in any other way altered it without authorisation.
4. Defects and damage subject to the complaint have been the reasons for a price reduction at the time of the Product purchase.
5. The damage has been caused as a result of the use of the Product in inadequate climatic conditions (inadequate microclimate in the room).
6. Defects in the Product have been caused by inappropriate assembly carried out contrary to assembly instructions by persons without written authorisation from the Producer.
7. Violation of principles concerning the Product safe use defined by the Producer, for instance the use of a chair by users weighing over 110 kg.

## How to make your Nowy Styl Group furniture comfortable and damage-free for a long time:

1. products must be used in accordance with the purpose they are intended for. Only correct assembly carried out according to instructions included in the assembly manual of the specific product, and subsequent sensible operation in conformity with user manual and these guidelines can assure long life of the product;
2. We pack our products very carefully, nevertheless the use of sharp tools to open packaging may cause damage to furniture;
3. Dents and irregular folds on upholstered furniture are most often caused by packing and transportation. Please wait calmly – the problem is normally gone after no later than a couple of days from unpacking;
4. Long life of office furniture is achieved when it is used in an office environment. Please try not to use our products at temperatures lower than 15°C and higher than 30°C. Relative air humidity should be kept between 35% and 70%;
5. High temperatures are destructive to furniture. Please do not place or store furniture directly next to heat sources such as radiators. Furniture should be placed at least 1 m away from a heat source;
6. Sunlight has a negative impact on the colour of materials furniture is made of. Prolonged exposure of product to direct sunlight may result in local discolouration;
7. Solvents and other chemicals as well as hot objects may damage furniture coatings. You can avoid tarnishes, discolouration and distortions by working with such objects and substances away from your furniture;
8. Objects with sharp and rough edges may damage furniture. You are advised not to move or place such objects on furniture surface;
9. Please use special caution when placing a heavy object on furniture. It may easily damage the surface. Upholstered furniture is particularly prone to deformation and denting;
10. Do not stand on furniture or sit on armrests and backrests. It may be dangerous to both yourself and the product! It may cause an accident or damage furniture components;
11. Loosened screws are a natural consequence of furniture use. Always act immediately if you notice that a screw has become loose. Please tighten all screws at least once every six months;
12. The most comfortable way of moving a piece of furniture is to hold it by its vertical walls. Do not hold by fittings and handles not intended for carrying as you can easily damage the product;
13. A desk or table should be lifted by its supporting structure, not by the top;
14. Please move fixed furniture by lifting it up – moving it may cause damage to the furniture or floor.
15. Before you start moving cabinets please remove their contents and lock doors and drawers;

15. At least two people are required to move a piece of fixed furniture unless otherwise stated in assembly manual;
16. One person is enough to move a piece of mobile furniture.
17. Please exercise special caution when using furniture covered with natural veneer. It should be protected from contact with hot objects and chemicals, and sharp or heavy objects should not be moved on its surface. You are advised to use pads for mouse, keyboard and other heavy objects. In case of liquid spillage on furniture surface please immediately wipe away the liquid with a soft absorbent cloth;
18. If you would like to move modular seats forming a set please first detach all components of the set. By moving individual components of a system separately you make sure they stay undamaged;
19. A chair is intended to seat only one person (whose weight as prescribed by standards should be no more than 110kg, for no longer than 8 hours a day) except for the chairs where expressly stated otherwise;
20. A sofa should not be used at the same time by more people than is provided for a given model (e.g. a 3-seater sofa must not be used by more than three people at a time);
21. As a standard all swivel chairs come equipped with hard, self-locking castors designed for soft surfaces. Castors for hard surfaces are available optionally;
22. Please use protective floor mats or get appropriate castors to avoid damaging the floor. The Manufacturer does not bear responsibility for damage to flooring caused by the use of products;
23. Repair or replacement of a gas lift can only be carried out by specially trained staff. Do not dismantle, disassemble or heat the gas lift on your own. It may result in damage to the gas lift and oil spillage;
24. Most of visitor chairs are stackable. For your own safety please do not stack chairs higher than as provided for in the instructions for the given model enclosed with this warranty. Curb weight and total weight of a product (including packaging) are indicated on the identification sticker located in an inconspicuous spot on the surface of the furniture. **Please note:** damage caused to a piece of furniture as a result of non-observance of these guidelines provides a basis for rejection of any complaints.

## Veneer-coated, melamine-coated and lacquered surfaces

Materials used in the manufacture of furniture include natural wood – veneer, as well as wood-based materials – melamine coated and raw fine chipboards, lacquered fibreboards and lacquered MDF. These surfaces should be cleaned with a soft, dry or wet fabric, and then wiped dry.

## Wood, plastics and chromium plated elements

Please bear in mind that wood is very prone to moisture. Detergents for cleaning wooden surfaces should therefore be mixed with small amounts of warm water. After cleaning furniture surface please wipe it dry. Wood, aluminum and chromium plated elements should be cleaned with generally available non-scratching detergents intended for the specific type of finish.

## Leather

With proper care, leather products can be preserved in perfect condition for many years. Leather should not be wetted, oiled or treated with abrasives. All dirty stains should be removed immediately. First, leather should be cleaned with a cloth slightly moistened in a mild cleaning solution of water and soap. Next, the surface should be wiped dry delicately. Use of vacuum cleaner is not recommended as it may result in scratched surface of leather. If special care agents for leather are used, it is recommended that the effect of the agent should be tested on a piece of leather before cleaning.

## Fabrics

To avoid fading of fabric, chairs, armchairs and sofas should always be protected from direct sunlight. All stains must be removed immediately. When removing stains and dirt from upholstery fabric please use a moist cloth soaked in warm water and delicate cleaning liquid and shampoo intended for the particular type of stain on furniture upholstery. It is recommended that the effect of the detergent should be tested on a piece of upholstery in an inconspicuous spot before cleaning. Additionally, fabric upholstery requires regular dusting. **Please note:** if improperly cleaned, furniture will wear much faster. Non-observance of these maintenance guidelines may provide a basis for rejection of any complaints.



EDITION 5  
04/2017

We KNOW HOW to  
**#MakeYourSpace**

[www.NowyStylGroup.com](http://www.NowyStylGroup.com)

